



MARINE PRODUCT GUIDE

APRIL 2026

TWIN DISC

ELECTRIFY YOUR APPLICATION

WITH OUR TURNKEY SOLUTIONS

TWIN DISC CAN HELP YOU CONFIDENTLY ELECTRIFY YOUR FLEET.

Twin Disc will thoroughly analyze your specific operating requirements and specify system components. Our process optimizes your confidence level and your investment.

If you're contemplating getting on board with hybrid or electric power, Twin Disc is the smart place to start. Contact GoElectric@TwinDisc.com.



TWINDISC.COM  WE PUT HORSEPOWER TO WORK®

THE TWIN DISC FAMILY OF PRODUCTS



TABLE OF CONTENTS

Twin Disc Marine Product Information	2-37
Service Classification Definitions	38
Important Application Information.	39
Pleasure Craft	40-45
Standard and QuickShift Marine Transmission Ratings	
Light Duty	47-51
Standard and QuickShift Marine Transmission Ratings	
Intermediate Duty	52-59
Standard and QuickShift Marine Transmission Ratings	
Medium Duty	60-67
Standard and QuickShift Marine Transmission Ratings	
Continuous Duty	68-75
Standard and QuickShift Marine Transmission Ratings	
Standard and QuickShift Marine Transmission Dimensions.	76-81
Veth Propulsion Definitions	82-83
Veth Main Propulsion Ratings	84-103
Veth Auxiliary Power Unit Ratings	104-109
Twin Disc Global Service	110-111
Twin Disc Locations	112-115

COVER: The cover image features a 78-foot by 26.7-foot research vessel built by All American Marine for Cal Poly Humboldt. Designed by Nic de Waal of Teknikraft Design, the vessel is powered by twin MAN D2862LE43B EPA Tier 4 engines with Twin Disc MGX-6599RV marine transmissions with a 2.48:1 ratio. The propulsion system was supplied by Palmer Johnson Power Systems, showcasing Twin Disc's advanced marine technology in action.

Photo courtesy of All American Marine.



Katsa has a long history in providing power transmission solutions to marine industries. Katsa supplies steering gear rims and pinions for steerable thrusters while also providing gearboxes for propulsion systems. Many offshore winches and oil drilling machinery are equipped with gearwheels, gear shafts and gear rings produced by Katsa. Moreover, Katsa offers gear units and components for fire pumps, PTO drives as well as winches and other deck machinery.

KATSA MARINE PTO/PTI CLUTCH SERIES HYBRID-READY

Power take-off clutches for thrusters and other marine applications.

- Three sizes: L250 –L350 –L490
- Wet running clutches
- Engine flywheel housings from SAE #3 up to SAE #00
- Flexible PTO/PTI connections
- Case carburized ground gearwheels
- Trailing pump
- Oil filter and cooler
- All classes available



Click to learn
more about Katsa

KATSA 2L550 SERIES

Katsa's 2L550 electric main propulsion gearbox has state-of-the-art design focused on highest efficiency and silent running. The gearbox has two inputs for electric motors combined to one thrust output for the propeller shaft. The integrated lubrication system ensures reliability and long service life for sustainable maritime operation.

2L550 TECHNICAL DATA		
Ratio i (min/max)	3.62	7.04
Max input power (kW)	3,000	1,785
Power factor (kw/rpm)	1.50	0.893
Max input (rpm)	2,000	2,000
Output torque (Nm)	51,500	60,000
Max thrust (kN)	-200 to 200	-200 to 200
Weight (kg)	4,000	4,000

*Integrated lubrication system with double-filter and oil cooler.
BV marine classification. Other marine classes on request.*

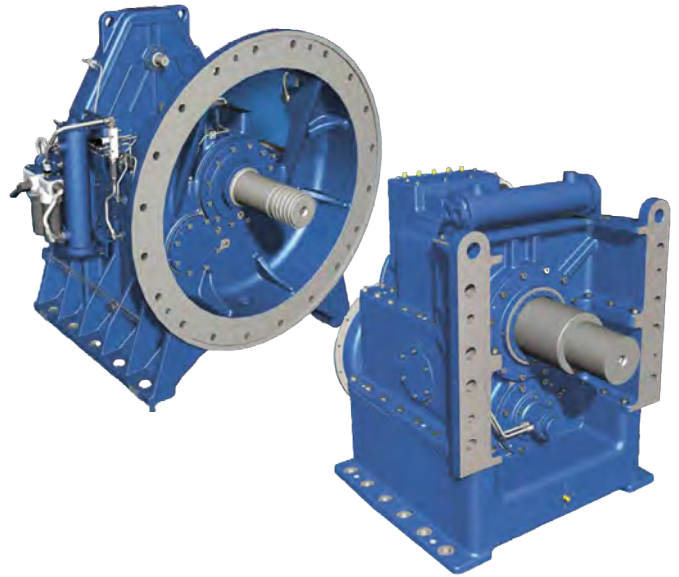
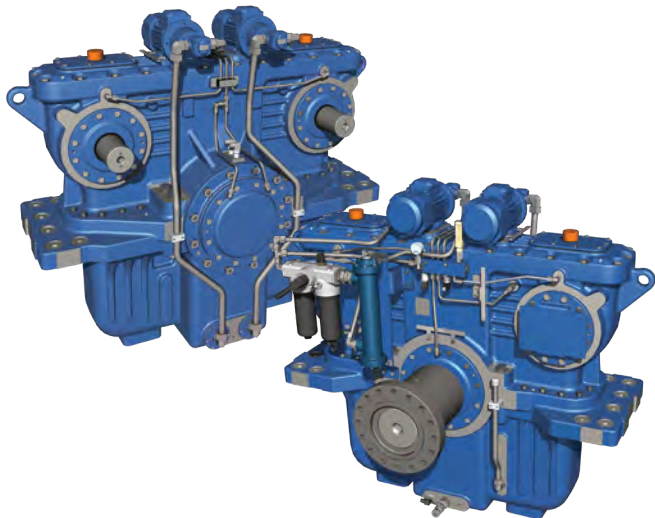

KATSA CLUTCH DREDGE PUMP GEARBOX SOLUTIONS

Katsa's clutch-actuated dredge pump gearboxes are designed for direct dredging pump mounting with a combination of gear reduction to safety input clutches, and PTOs for hydraulic pumps and other accessory drives. The dredging pump is actuated with an integrated hydraulically-operated wet running clutch. An integrated lubrication system ensures long service life and easy maintenance.

TECHNICAL DATA

- Pump direct mount
- Input power range up to 1,500 kW
- Outputs and typical gear ratios
i = 2.5 to 3.5 for dredge pump
i = 1.5 to 2.5 for PTO and accessory drives
- Hydraulically-operated wet running clutch for dredge pump
Torque up to 40,000 Nm
Force at output shaft up to 300 kN
- Integrated lubrication system with double filter and oil cooler
- Designs available for submerged conditions

VETH AZIMUTH THRUSTERS

The basic principle of an azimuth thruster is simple and effective. The propeller rotates 360° around its own vertical axis to guarantee maximum maneuverability in all directions.

Our azimuth thrusters are available in either Z- or L- drive configurations and can be powered by any power source; the control for its azimuth steering system can be either electric or hydraulic. The thruster units are available with open propeller, contra-rotating propellers or with a nozzle. Veth Propulsion has developed the Veth Integrated L-drive with a permanent magnet (PM) motor, which has extremely low mounting space requirements.

Veth Propulsion maintains a full stock of standard parts to ensure fast service.

INTEGRATED L-DRIVE

- Compact design; extremely low mounting space requirements
- High efficiency
- Quiet
- Low weight
- Built using proven Veth Propulsion technology
- Outstanding maneuverability due to the 360° thrust
- Electric motor inside the ship; fewer vulnerable components underwater
- Simple to install
- Slip ring cabinet unnecessary
- Optimal flow of water thanks to revamped tail on contra-rotating propeller
- Available in open, nozzle or contra-rotating propellers

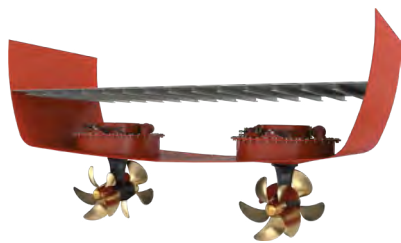
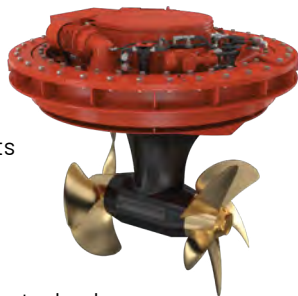

Z-DRIVE/L-DRIVE

- 360° full thrust for optimal maneuverability
- Possibility for flexible suspension (better insulation from noise and vibration)
- Ability to change propeller without docking
- Simple to install
- More room for passengers/cargo due to compact construction
- No separate gearbox needed
- Ideally suited for Dynamic Positioning (DP)
- Safer, through shorter emergency stopping distance and improved maneuverability
- Available in open, nozzle or contra-rotating propellers



The L-Drive system features azimuth thrusters powered by vertically mounted electric motors, which eliminate the need for a second bevel gear, thereby enhancing efficiency and reducing noise. In contrast, the Z-Drive employs a gear train with two right-angle turns, creating a "Z" shape, effectively linking the drive motor to the azimuth thruster for efficient propulsion.

Click to learn more about Veth Propulsion

VETH
PROPULSION
BY TWIN(DISC)

VETH BOW THRUSTERS

Veth Bow Thrusters offer exceptional maneuverability, making docking and dynamic positioning effortless. Designed for minimal noise and vibrations, they ensure a smooth and quiet onboard experience. Available in various configurations, they suit different vessel types and operational needs. Built with proven technology and durable components, Veth Bow Thrusters guarantee reliable performance while enhancing efficiency, reducing fuel consumption, and improving overall vessel handling.

VETH JET

The Veth Jet channel bow thruster, an invention of Veth's founder, was launched in 1970 in response to market demand for a thruster that could function optimally at 360° with a shallow draft.



VETH COMPACT JET

The Veth Compact Jet can be found only at Veth Propulsion. A special feature of the Veth Compact Jet is that the propeller is placed at an angle of 17° in a housing that rotates 360°. In practice, this means more efficiency and higher thrust on a sailing vessel.



VETH STEERING GRID

With a Veth Steering Grid, you achieve optimal thrust at minimum draft, even at speed and with no parts extending from beneath the vessel. The Veth Steering Grid makes use of existing technology found in the successful Veth Jet, such as the steering gears and drive transmission.



VETH COMPACT GRID

The Veth Compact Grid offers the advantages of two existing Veth solutions: the simplicity of the Veth Steering Grid and the angled propeller of the Veth Compact Jet.



VETH TUNNEL THRUSTER

Veth Tunnel Thrusters utilize a streamlined angular gear drive with a propeller mounted in the tunnel. At the top of the tunnel, an electric or hydraulic motor is mounted, which drives the rotation in two turning directions (port and starboard). When the tunnel bow thruster is driven by a diesel engine, an angular gear drive with a reverse clutch is used.



Each vessel is unique and it may be that a regular tunnel thruster does not meet your needs. Veth Propulsion also offers aluminum, flexible mounted (combined with air injection), elbow or retractable tunnel thrusters.

VETH CONTROL SYSTEMS

IN-HOUSE EXPERTISE

Like all our products, our Veth Control Systems (VCS) are developed and produced internally using proven technology like CAN bus for internal communication, offering Veth Propulsion the opportunity to read out, monitor and analyze data and alarms. Our in-house R&D department is engaged with development, innovation and improvement of our control systems on a daily basis, making decisions based not only on dynamic and proven technologies but also with reliability and ease of use in mind.



CONTROL PANEL



CONTROL MAIN DISPLAY



TUNNEL PANEL



LOCAL CONTROL PANEL



DRIVEN BY RELIABILITY

Using redundant communication and power supply architecture, Veth has designed a highly reliable system that ensures full functionality in case of a single communication or power failure. Even if a main control module fails, a backup system is in place which can be activated by the user to gain control of the primary thruster functions.

FEATURES & BENEFITS

- Fast and remote service capabilities upon request
- Panels protected from dust deposits and heavy seas
- Integrated backup system for main propulsion
- Up to eight control locations with central system to transfer between locations
- E-shafted handles automatically line up the controls and guarantee a smooth transfer
- Redundant CAN bus communication & system data logger
- Multiple industry standard interfaces



DIFFERENT HANDLE TYPES

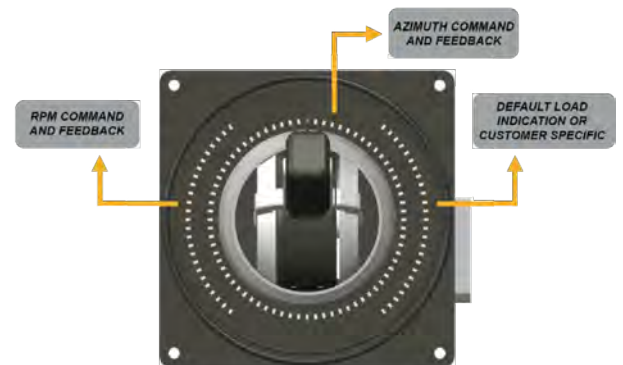

BUILT-IN HANDLE OPTIONS

TWIN DISC WELCOMES KOBELT: EXPANDING EXPERTISE IN STEERING, CONTROL AND BRAKING SYSTEMS

Based in Canada, Kobelt Manufacturing Co. Ltd. brings over 60 years of experience designing and manufacturing steering, control and braking systems for marine and industrial applications. The company's in-house foundry, machining and testing operations support precise craftsmanship and long-lasting performance.

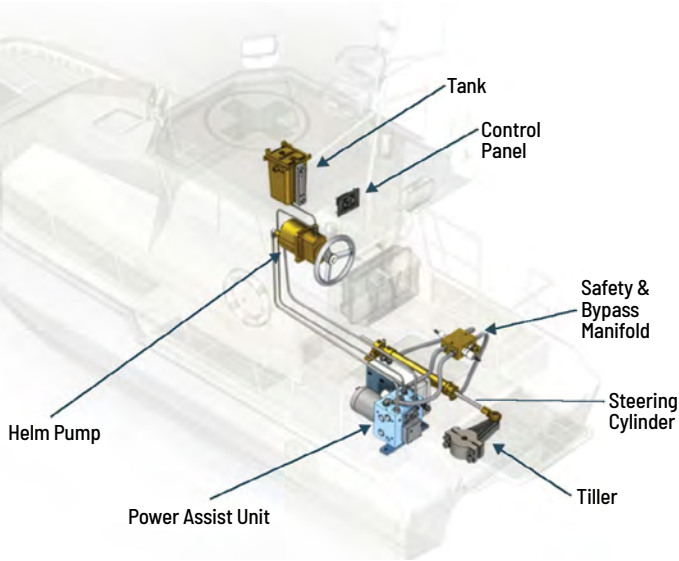

KOBELT SHAFT BRAKES

Specific to marine, Kobelt brakes are widely used in various winch applications, renewable energy projects, as well as shaft brake applications for boats of all sizes.



INTRODUCING THE NEXT GENERATION OF DIGITAL STEERING

Designed for unmatched precision and responsiveness, this advanced system delivers smoother handling, greater control at all speeds and enhanced safety in demanding conditions. With integrated digital intelligence, it reduces operator effort, simplifies installation and maintenance, and ensures reliable performance for years to come—whether on commercial vessels or luxury yachts.

FEATURES & BENEFITS

- Precision Control – Advanced electronic signals replace mechanical linkages, delivering smoother, more accurate helm response and reducing operator fatigue.
- Enhanced Safety & Reliability – Built-in redundancy and real-time system monitoring ensure dependable performance, even in the most demanding marine environments.
- Flexible Integration – Compact, modular design simplifies installation and seamlessly connects with other onboard digital systems for greater vessel efficiency.



DIGITAL STEERING STATION



DIGITAL HELM



DIGITAL STEERING CONTROLLER

HYBRID-READY MARINE CONTROL DRIVES

FIELD PROVEN, MODERN DESIGN

Capitalizing on more than 30 years of rugged applications, the new Twin Disc Marine Control Drives (MCD) Series offer distinct operating advantages for any vessel requiring highly accurate positioning or extreme slow-speed maneuverability while splitting main engine power to operate high-powered FiFi pumps or other auxiliary gear. Power capacities now range from 1680 to 5250 kW (2250 to 7040 HP).

FEATURES & BENEFITS

- Provides operating advantages for vessels requiring highly accurate positioning
- Used in conjunction with azimuth thruster systems
- Best alternative to controllable pitch propellers (CPP)
- Dynamic Positioning (DP) capable
- High-capacity PTO to drive auxiliary equipment
- Optional PTI for secondary propulsion power source, up to 10,600 Nm torque on MCD output shaft
- Emergency “come home” device per classification requirements
- Smooth, gradual propeller speed change resulting in improved maneuverability
- Safer and easier vessel control during slow speed maneuvering and docking
- Adjustment of propeller speeds below engine speed rating
- Divides the power from the main propulsion engine to eliminate the need for auxiliary engines
- Delivers an instant response when required
- Bearing calculated for high universal joint angles at maximum power
- Compared to controllable pitch propeller (CPP), the Marine Control Drives can be serviced inboard without the need to dry-dock or diver support
- Slipping from engine idle to wide open throttle; Twin Disc expert application team will help customize to any desired operator requirement

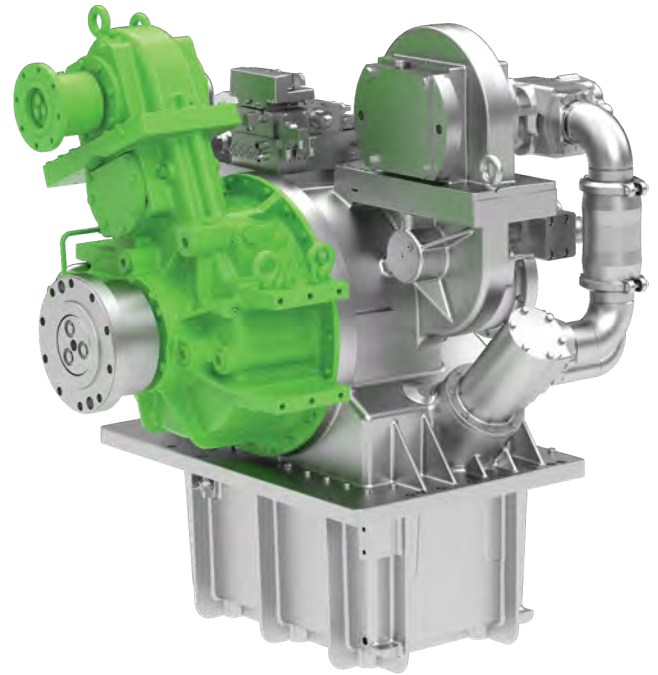

LD MODELS	
Model	kW/rpm
2000-1-LD	1.20
2000-2-LD	1.60
2000-3-LD	2.00
4000-1-LD	2.40
4000-2-LD	2.80
4000-3-LD	3.20
4000-4-LD	3.60
4000-5-LD	3.75

HD MODELS		
Model	kW/rpm	Dissipation
2000-1-HD	1.20	100 kW
2000-2-HD	1.60	130 kW
2000-3-HD	2.00	160 kW
4000-1-HD	2.40	190 kW
4000-2-HD	2.80	225 kW
4000-3-HD	3.20	250 kW
4000-4-HD	3.60	290 kW
4000-5-HD	3.75	330 kW
5000-1-HD	3.75	400 kW
5000-2-HD	3.75	450 kW

Click to learn more about Marine Control Drives

EC600PC PROPULSION CONTROL SYSTEM

ADVANCED MARINE ELECTRONIC PROPULSION CONTROL SYSTEM

With the controller prewired to your QuickShift transmission, the EC600PC is the simplest control system to install, eliminating the need for remote mounting, extra wiring and labor. Simply add a control head/station and you have a complete system to control your engine and transmission.

FEATURES & BENEFITS

- EJS and EPS ready
- Independent CAN station busses provide maximum redundancy and reliability
- Additional isolated CAN bus for communication between multiple EC600PCs
- Dual power inputs
- Computer-based setup and diagnostics
- Express mode leverages full capabilities of Quickshift transmissions to deliver seamless shifting and unparalleled ease of operation
- Minimal manual setup required with SmartChip™ interface
- Interface for all electronically governed engines
- Throttle limit and clutch disable modes
- Shaft brake control interface
- Stabilizer disable interface
- Station lockout and transfer options
- Suitable for up to six shaft lines and six control stations
- Type approvals and unit certifications by major marine survey societies are available
- Operates with EC300 digital control heads utilizing highly reliable Hall Effect lever position sensors for longest shifting life possible
- RoHS compliant



Joystick and display are optional equipment.

EC600PC PROPULSION CONTROL SPECIFICATIONS

Operating modes	Cruise/Sync/Express/Troll
Operating temperature	-40° to +85°C
Nominal operating voltage	12-24 VDC nominal
Communications	SmartChip™ LIN interface, SAE J1939 programming and station data links, SAE J1939 and NMEA 2000 communication protocols
Protection Class	IP67

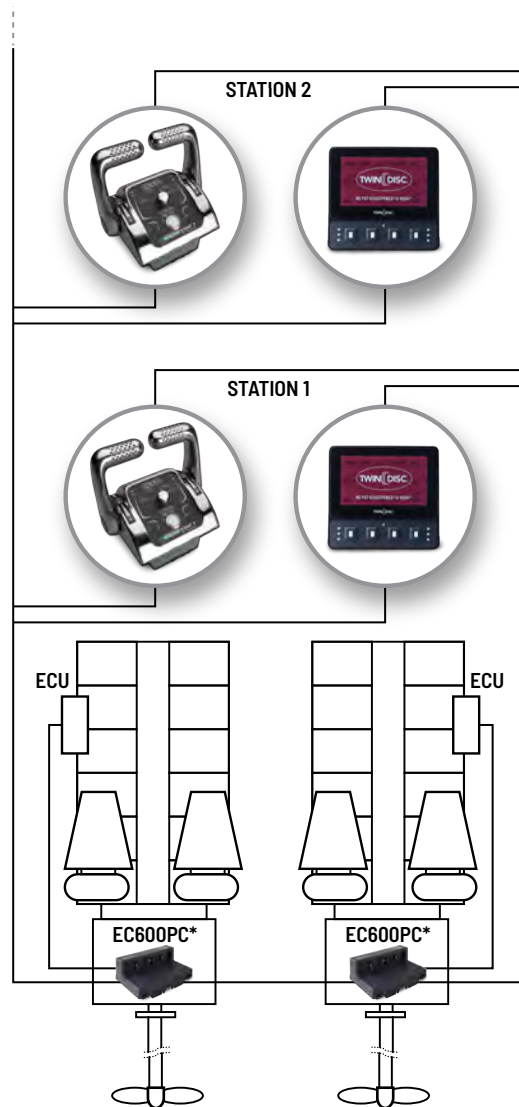

*Transmission mounted

System example shows a non-redundant setup for a twin engine installation with two stations.

EXPRESS JOYSTICK SYSTEM® (EJS®)

DON'T BUY YOUR NEXT BOAT WITHOUT IT

The Twin Disc Express Joystick System (EJS) absolutely revolutionizes docking and slow speed maneuvering of diesel powered, conventional shaftline boats.

With easy fingertip movements you control direction and speed – instantaneously and intuitively. No lugging. No lurching. No clunking. All thanks to proven QuickShift transmission and EC600PC control technology.



FEATURES & BENEFITS

- “Push, twist and go” directional maneuvering
- Proven QuickShift transmission and EC600PC control technologies
- Simultaneously and instantaneously controls engines, transmissions and thrusters
- During docking, eliminates steering wheel and control lever activities
- Effortlessly move the boat in any direction and even pivot on its own axis
- Extremely intuitive and easy to learn
- Ergonomically friendly
- Interfaces are available for many popular thruster manufacturers including Veth Tunnel Thrusters; please contact Twin Disc for availability

Click to learn
more about Express
Joystick Systems

EXPRESS POSITIONING®

MAINTAIN POSITION WITH THE TOUCH OF A BUTTON

Based on the award-winning EJS, Express Positioning maintains a vessel in a fixed position and heading at the touch of a button. A dedicated, highly accurate and reliable GPS receiver determines the vessel's exact location and heading and the Twin Disc EC300JS controller commands the Twin Disc QuickShift transmissions and installed bow/stern thrusters to smoothly and instantaneously maintain the precise station coordinates and heading.* Never before have shaft line boats been able to so effortlessly hold position.



BY TWIN(DISC)

FEATURES & BENEFITS

- Works only in conjunction with Twin Disc Express Joystick System
- Maximum power available to continuously hold station without producing excess heat or wear
- Compatible with single- and twin-engine applications
- Compatible with twin-engine bow or bow/stern thruster applications
- Can be retrofit to existing EJS applications
- Based on years of experience with Dynamic Positioning systems in commercial vessels
- Only QuickShift transmissions provide the smooth, responsive shifting and propulsion control required
- QuickShift transmissions and precision hydraulic thrusters provide ultra fine maneuvering control at low thrust levels

* Vessel position may not be maintained in all sea and weather conditions. Captain is responsible for the safe operation of the vessel.

Click to learn
more about Express
Positioning

Sample Diagram



- 1 EC600PC: Standard control system for up to six digital stations and engine/transmission shaft lines per vessel.
- 2 EC300JS: Express Joystick System option for up to six joystick stations.
- 3 Available GPS option, station-keeping, Express Positioning System.
- 4 Twin Disc QuickShift transmissions required.

PLEASE CONTACT TWIN DISC OR A TWIN DISC AUTHORIZED DISTRIBUTOR FOR MORE DETAILS.

EC300DP ELECTRONIC CONTROL SYSTEM

HIGH PRECISION PROPULSION CONTROL FOR DYNAMIC POSITIONING

The Twin Disc DP propulsion control package allows instantaneous, shockless and virtually constant forward and reverse shifting to keep supply vessels on station as directed by the craft's dynamic positioning system. Drivelines can execute directional reversals at variable torque levels more than 30 times per minute to hold station with the full requirements of the DP class.

FEATURES & BENEFITS

- High thrust rate change competitive with alternative drive packages
- More than 30x/minute directional reversals
- Designed for conventional shaft lines with QuickShift transmissions
- Linear thrust control from 10% of idle engagement to full engine power
- Maintain fuel-efficient engine speeds even at low propeller speeds
- Meets DP2 requirements
- Enhanced installation, monitoring and maintenance/service software
- Versatile, rugged and easy to install
- Designed to interface with all popular electronic engines and DP systems



QUICKSHIFT®

DP INTERFACE SYSTEM (EC300DP) – Sample Diagram

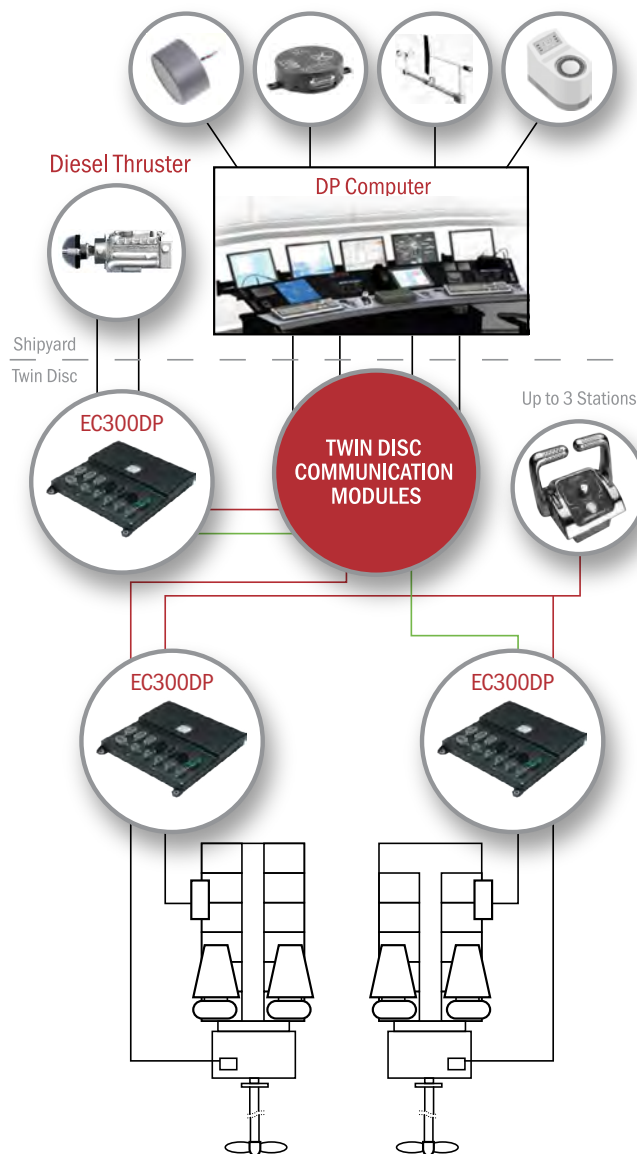

1. The Twin Disc EC300DP control system is suitable for DPO, DP1 and DP2 vessels with conventional propellers and two (2) or more engine/transmission drivelines.
2. Twin Disc QuickShift transmissions required.

PLEASE CONTACT TWIN DISC OR A TWIN DISC AUTHORIZED DISTRIBUTOR FOR MORE DETAILS.



QUICKSHIFT®
BY TWIN(DISC)

FAST, SMOOTH SHIFTS

No other marine transmission in the world shifts as fast and smooth as the Twin Disc QuickShift, yet provides amazing control at near zero vessel speed.

FEATURES & BENEFITS

- Completely internal and integrated clutch actuating system
- Regulates engine torque at extremely low speeds to slow the propeller speed down to 50 rpm or less – allowing you to maneuver at near zero boat speed, an incredible advantage in docking
- Instantly delivers cushioned torque to the driveline when shifting from neutral to anywhere from full ahead to full reverse
- Eliminates driveline shock while optimizing power to the driveshaft
- Steep but smooth power curve (full out or at slow speeds)
- Superior maneuvering control
- Instant power to propeller

Click to learn more
about QuickShift
transmissions

SAILING EASE AND VERSATILITY

The SeaProp 60 saildrive is a propulsion system for sailboats with engines rated up to 56 kW (75 hp) @ 3600 rpm. Sailboat manufacturers and operators alike benefit from this system's unique but proven design.



FEATURES & BENEFITS

- Easy, space-saving installation
- Eliminates propeller shaft along with stuffing box, cutless bearing, stern tube and strut
- Can be matched with a variety of fixed or foldable propellers
- Sailboat manufacturer will overcome inherent limitations and problems of conventional inboard shaft drive installations with a quicker, more versatile and simplified engine installation process
- Easily mounted facing forward or aft
- Not constrained by shaft angle and offers the builder more versatility in engine placement and a smaller 'footprint' (no shaft, stuffing box, or strut aft of the engine)
- Increased propulsion efficiency as the thrust is parallel to the boat's waterline
- More efficient, quieter, creating less vibration to the boat and providing an all-around smoother experience
- No water leakage into the bilge through the stuffing box

SAILDRIVE SP60 TECHNICAL DATA

RATIO		INPUT RATINGS – PLEASURE kW (HP)		
Forward	Reverse	2,800 rpm	3,000 rpm	3,600 rpm
2.15	2.15	43 (59)	46 (63)	55 (75)
2.38	2.38	34 (46)	36 (50)	44 (60)

Max Input Speed: 3800 rpm
Dry Weight: 43 kg (94 lbs)
Oil Quantity: 2.8 liters (0.7 gallons)

Click to learn
more about
SeaProp 60



COMPACT. SILENT. SUSTAINABLE.

Based on years of experience and fine-tuned for optimal performance, ELITE is a 360° thruster dedicated to the needs of modern yachting. Combining the best in Rolla's "S" Class Propellers and Veth's Contra-Rotating technology with the successful Veth Integrated L-drive thruster, the ELITE series offers a wide range of benefits, designed to enhance yacht efficiency while significantly lowering emissions. It achieves optimal noise and vibration reduction. This improvement not only benefits marine ecosystems but also greatly enhances the onboard experience.

The ELITE thruster sets a new standard for onboard efficiency. Its compact design frees valuable space, allowing designers greater flexibility to enhance the yacht's layout and functionality.



FEATURES & BENEFITS

- Contra-rotating propellers improve fuel efficiency, allow for superior maneuverability, and offer a smooth and quiet operation
- PM motor is 40% to 60% more compact than an asynchronous motor, offering more design freedom and additional room for tenders and water-sports equipment
- Revamped tail results in decreased drag and reduced noise generation
- Control systems consisting of a redundant data bus, emergency stop and backup functions, e-shafted levers and easy-to-read displays can be tailored to specific project needs

Click to learn
more about
ELITE thrusters

HYBRID-READY TRANSMISSIONS



Click to learn more about Hybrid-Ready Transmissions

MGH TRANSMISSIONS

Twin Disc has taken its field-proven marine transmissions and implemented hybrid-ready features to create these innovative marine transmissions for parallel hybrid propulsion. These hybrid-ready systems support greener power transmission while delivering the reliability you expect from Twin Disc.

HYBRID-READY FEATURES

- MasterClutch™
- PTI gearbox
- Available model: MGH-5075SC.

Additional models in development; please inquire about availability.



MASTERCLUTCH

- Permits power generation through PTO/PTI in forward, neutral and reverse
- Prevents engine back-driving during electric-only operation
- Supports all features of QuickShift transmission

PTI GEARBOX

- Drives transmission primary shaft (same as engine) with MasterClutch providing disconnect
- Allows for standard speed/smaller e-motor through motor speed reduction
- Standard reduction ratios from 1.0:1 to 2.25:1
- Offset to propeller shaft enables installation of large motors
- PTO available for onboard hydraulics (e.g., steering pump)



MGE TRANSMISSIONS

Twin Disc built on its marine transmission expertise to create the MGE Series of gearboxes. This design provides power from the motor immediately in both clockwise and counter-clockwise directions. All units are equipped with a bi-directional oil pump to provide lubrication no matter the direction of shaft rotation, making these units a perfect fit for serial hybrid and diesel-electric applications or any application requiring a direct power response with a ratio reduction.

FEATURES & BENEFITS

- Bi-directional lubrication pump
- Simplified design without a clutch
- Same installation envelope as standard marine transmission
- Standard marine transmission ratings apply
- Type approvals and certifications available upon request
- Available models
 - MGE-5065SC
 - MGE-5126SC
 - MGE-5204SC

Additional models in development; please inquire about availability.

HYBRID AND ELECTRIC SYSTEM SOLUTIONS

GO ELECTRIC

As leaders in power transmission technology, our innovative hybrid and electric systems support greener power transmission while delivering the reliability you expect from Twin Disc. We deliver the solutions that best fit your specific application: diesel power, full electric, or a hybrid system that takes advantage of both.

EVOLVING OPTIONS, GROWING BENEFITS

Hybrid and electric systems give you a better way to:

- Be environmentally friendly
- Meet emissions standards as well as stakeholder expectations
- Save on fuel and maintenance costs
- Reduce noise and vibration
- Increase efficiency

Here's how we define the options:

Full electric systems eliminate the main diesel engine and its maintenance costs, and cut fuel costs and emissions. Configurable power-dense energy storage systems efficiently provide the energy needed to power the application.

Serial hybrid systems use electric motors to replace the traditional main diesel engines, drawing electric power from onboard gensets, or an energy storage system in combination with gensets.

Parallel hybrid systems pair the diesel engine with an electric motor. This configuration allows for a diesel-only, electric-only, and boost mode, taking advantage of both.

FULL ELECTRIC

This full electric propulsion system example uses a single electric motor per drivetrain. It's most suitable for short-trip vessels (e.g., ferries, pilot boats, inland waterways vessels, harbor vessels, small yachts, and fish-farming vessels) with sufficient shore time to charge batteries between excursions, and for those operating in restricted areas and zero-emission zones.

SYSTEM OVERVIEW

- Serial hybrid using electric power
- Machinery compartments can be located to optimize cargo space or meet class requirements

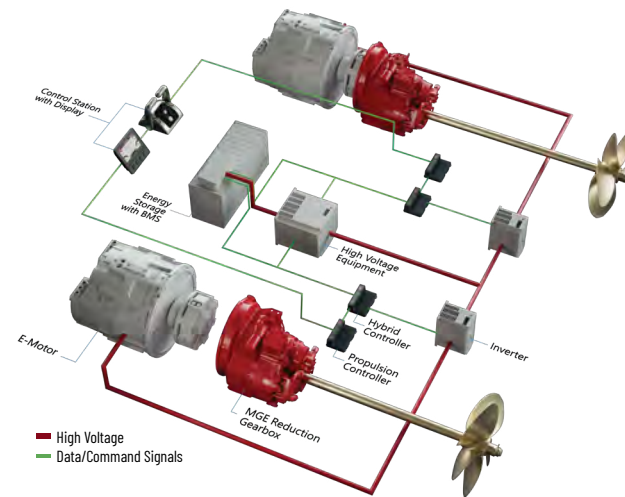

Components include:

Reduction Gearbox (MGE)
Propulsion Controller
Hybrid Controller
E-Motor, Inverter, High Voltage Equipment
Energy Storage

Click to learn
more about
Go Electric

Click to learn
more about Full
Electric systems

SERIAL HYBRID

This serial hybrid system example uses an electric motor and can both generate power and store energy. The system optimizes fuel consumption with a generator. It's best suited for vessels operating in restricted areas and zero emission zones.

SYSTEM OVERVIEW

- Serial hybrid using electric power
- Optimizes fuel use via gensets operating at the top of their fuel efficiency range. When propellers operate at low power, some gensets can be switched off, and the rest continue in their optimal range
- Machinery compartments can be located to optimize cargo space or meet class requirements

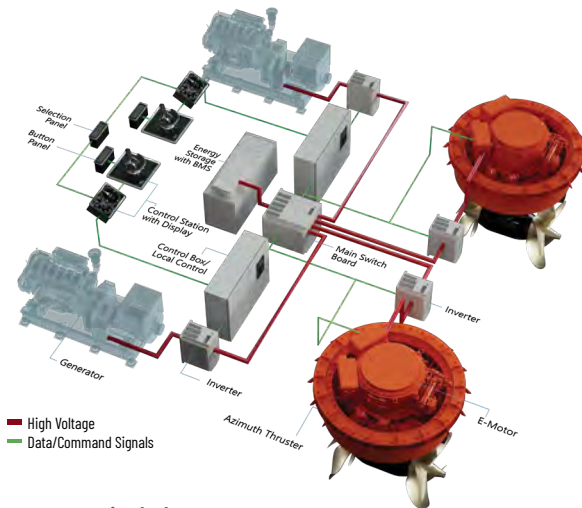

Components include:

Azimuth Thruster with E-Motor
Propulsion Controller
Inverter, High Voltage Equipment
Energy Storage
Generator

Click to learn
more about Serial
Hybrid systems

PARALLEL HYBRID

This parallel hybrid system example is capable of generating electricity for hotel loads. It's most suitable for vessels with long waits between jobs (e.g., tugs, pilot boats, workboats in general, military vessels, and yachts), and for those operating in restricted areas and zero-emission zones. Twin Disc technology enables implementation into any standard marine transmission

SYSTEM OVERVIEW

- Parallel hybrid using diesel and electric power
- During low-power operation, the e-motor can use excess diesel power to generate electricity for hotel loads, allowing the generator to be shut down
- In high-demand phases, electric power can boost diesel power

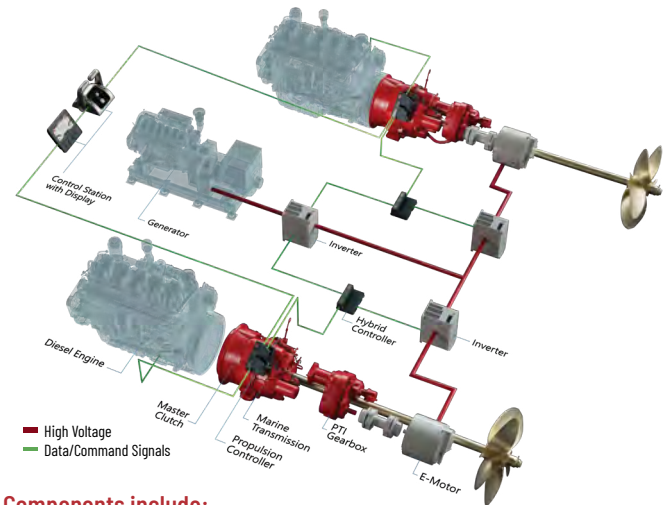

Components include:

MGH Marine Transmissions (with MasterClutch and PTI Gearbox)
Propulsion Controller
Hybrid Controller
E-Motor, Inverter, High Voltage Equipment

Click to learn
more about Parallel
Hybrid systems

SPEED IS JUST THE BEGINNING

Mechanical innovator and offshore racing enthusiast Howard Arneson perfected the performance and reliability of surface-piercing propulsion. Twin Disc then made Arneson Surface Drives available for non-racing applications – pleasure craft and commercial vessels, as well as military applications. Arneson Surface Drives are renowned as the most reliable and proven surface-piercing propulsion system with decades of successful applications in pleasure, commercial and military vessels.



Click to learn more about Arneson Surface Drives

FEATURES & BENEFITS

- Trimmable propeller shaft allows captain to adjust propeller submergence to optimize propulsion in varying conditions including change of sea state, additional payload, shallow water operation
- Completely eliminates cavitation, thus increasing propeller performance while reducing cavitation erosion
- Manufactured using high-quality, corrosion-resistant materials - maximizing uptime throughout the entire life of the vessel - for even the toughest applications
- Models designed to fit virtually every powerplant option, accommodating torque outputs up to 16,500 lb-ft (22,400 N-m)
- Can be combined with Twin Disc QuickShift transmissions and EC600PC control systems for the ultimate experience

- Accelerate faster and achieve higher top end than conventional drives
- Reduces underwater drag by 50% compared to conventional submerged propellers, resulting in significantly more efficient thrust
- Achieve the same performance with a smaller, more cost-effective engine compared to traditional submerged propellers
- Better payload-to-power ratio
- Outperforms waterjets in high-speed applications
- Enhanced contactless position sensors for trim and steering cylinders, gauge included

MODEL		ASD08	ASD10
HORSEPOWER ACCEPTANCE	GASOLINE @ 5200 rpm	To 990	To 1485
	DIESEL @ 2400 rpm	To 380	To 565
	GAS TURBINE	Contact Twin Disc, Inc.	
ASD INPUT SHAFT TORQUE LIMITS ¹ (lbs-ft)		1200	2000
NOMINAL SHAFT SIZE (inches)		2.00	2.50
UNIT WEIGHT (pounds, dry, includes ASD unit, trim and steering cylinders, trim pump, reservoir, mounting hardware and hoses) ²		B 285	B 415
OVERALL EXTERNAL LENGTH (inches)		42	53
THRUST SOCKET DIAMETER (inches)		8	10
THRUST SOCKET FLANGE DIAMETER (inches)		12	14
TURNING ANGLE (total)		40°	40°
PROPELLER TRIM CONTROL (vertical travel)		15°	15°

1. Torque ratings shown are nominal and may vary due to vessel characteristics.

ASD11S	ASD12	ASD14	ASD15S	ASD15L	ASD16
—					
To 850	To 1400	To 1800	To 2100	To 2400	Contact Twin Disc, Inc.
Contact Twin Disc, Inc.					
3200	4800	8000	11500	13500	16500
2.875	3.30	3.50	4.50	4.50	4.50
B 515	B 785	B 1135	A 1500	A 1540	A 1985
57	63	71	78	78	87
10	13	15	19	19	20
14	17	19	21.25	21.25	23
40°	40°	40°	36°	36°	36°
15°	15°	15°	15°	15°	15°

2. A: Aluminum housings

B: Bronze housings

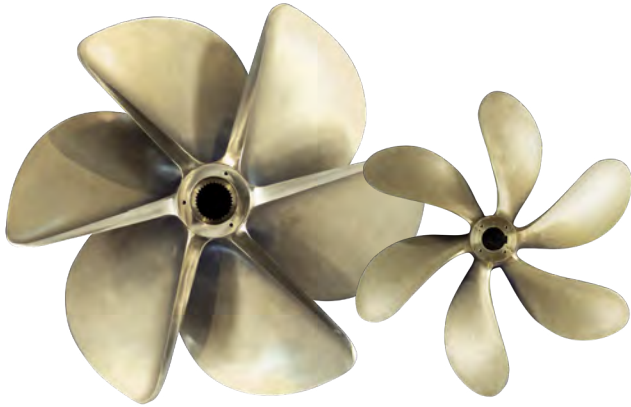

ROLLA™
BY TWIN DISC

ULTIMATE PROPELLER PERFORMANCE

Since 1963 the name Rolla has been synonymous with the highest quality, most efficient propellers in the world. What started with Philip Rolla individually designing and crafting race-winning propellers has grown to become the leader in propeller technology for high-performance pleasure and commercial craft and military vessels.

FEATURES & BENEFITS

- Rolla stainless steel and NiBrAl propellers range from 16 inches to 10 feet in diameter
- Specifically custom designed for high-performance shaftline or surface drive applications
- Wide variety of service for every aspect of propeller design, manufacture and application
- Offers complete hydrodynamic analysis and engineering capabilities to computational fluid dynamic (CFD) hull analysis to sea trials

Click to learn
more about
Rolla Propellers

NiBrAl AND STAINLESS STEEL PROPELLERS

The choice between NiBrAl and stainless steel propellers depends on each specific application. In general, fully submerged propellers are manufactured in NiBrAl up to 3.5 meters diameter with a power range from 500 hp up to 5,000 hp. Surface piercing propellers are manufactured in NiBrAl up to 60" diameter with a power range from 500 hp up to 5,500 hp and in stainless steel – duplex or 17.4PH – up to 28" diameter with a power range from 250 hp up to 1,500 hp.

COMPUTATIONAL FLUID DYNAMICS (CFD)

CFD is a strategic tool to optimize the hull design, including appendages, and study the best combination between the optimized hull and custom propeller. Rolla is at the forefront of developing advanced tools to analyze the flow dynamics around partially submerged propellers and has developed computational fluid dynamic (CFD) programs based on the panel method for analyzing submerged propellers. Multiple iterations of the propeller, with even the most minute changes in parameters, can be created and tested, ensuring the best possible outcome for the customer.

ROLLA FIN CAP

Fin Cap can be used with conventional submerged propellers and increases efficiency and performance by reducing fuel consumption and engine load.



SERVICE CLASSIFICATION DEFINITIONS

PLEASURE CRAFT

Up to 500 hours/year, low load factor usage planing hull vessels where typical full engine throttle operation is less than 10% of total time. The balance of operation at 80% of full engine throttle or less. Marine transmissions for use in long range pleasure cruisers, sportfish charter boats/patrol boats do not qualify for Pleasure Craft Service.

Note: Some revenue-producing applications such as Planing Hull Bristol Bay Gillnetter do qualify under Pleasure Craft rating definition.

LIGHT DUTY

Relatively low hour usage (less than 1500 hours/year) where full throttle operation is 2 hours out of 12. Typical applications include planing hull vessels such as fire boats, sport-fish charter boats and patrol/customs boats. This rating is also applicable to some bow and stern thruster applications.

INTERMEDIATE DUTY

Hour usage of up to 2000 hours/year (for models MG(X)-5114 and smaller) and up to 3000 hours/year (for models larger than MG-5114) with 50% of the operating time at full engine rating.

Typical applications include planing hull vessels such as ferries, fishing boats, some crew boats, and also some displacement hull yachts as well as some bow and stern thruster applications.

MEDIUM DUTY

Hour usage of up to 4,000 hours/year with up to 80% of operating time at full engine power. This duty classification is for usage where some variations in engine speed/power occur as part of normal vessel operation.

Typical vessels include mid-water trawlers, crew/supply boats, ferries and some inland water tow boats.

CONTINUOUS DUTY

For use in continuous operation with little or no variation in engine speed/power settings.

Typical vessels include fishing trawlers, tow/tug boats and ocean going vessels.

SPECIAL APPLICATIONS

Some applications such as Dynamic Positioning (DP), Wind Farm Service, and others, require Twin Disc Factory Approval.

IMPORTANT APPLICATION INFORMATION

- Transmission ratings are based on use of the transmission in a torsionally compatible system utilizing a suitable input torsional coupling.
- Ratings are for diesel engines at the indicated speeds, unless otherwise indicated.
- Ratings are shown in SAE horsepower (HP).
- Consult factory for ratings applicable to gasoline engines, gas turbines, or other applications not conforming to the given service class definitions.
- Ratings apply to right hand engines (i.e., counter-clockwise flywheel rotation when viewing rear of engine).
- Transmission ratings should equal or exceed the engine's published ratings for the given application.
- Final marine transmission selections are to be confirmed prior to issuance of the purchase order. For unusual or unique applications, please contact Twin Disc, Inc. for product selection assistance.
- Marine transmission input couplings provided by Twin Disc are configured to interface with engine flywheels which conform to SAE J620 standards. Please consult Twin Disc when use of non-standard flywheels are considered.
- Most of the transmissions listed herein are to be mounted directly on the SAE flywheel housing of the engine. It is necessary that the engine crankshaft endplay be measured before the driven equipment is installed and rechecked after the driven equipment is installed. The endplay measurements, before and after transmission installation, should be the same. If not the same, the driven equipment should be removed and the problem source located and corrected before the engine is started. Engine crankshaft endplay measurement is considered mandatory.
- The given data is subject to modifications/corrections without prior notice.
- Use certified print for installation.

IMPORTANT NOTICE

Disregarding propulsion system torsional compatibility could cause damage to components in the drive train resulting in loss of mobility. At minimum, system incompatibility could result in gear clatter at low speeds.

The responsibility for ensuring that the torsional compatibility of the propulsion system is satisfactory rests with the assembler of the drive and driven equipment.

Torsional vibration analysis can be made by the engine builder, marine survey societies, independent consultants and others. Twin Disc is prepared to assist in finding solutions to potential torsional problems that relate to the equipment of Twin Disc Incorporated's supply.

MODEL	RATIOS	KILOWATTS (HORSEPOWER)			MAXIMUM SPEED (RPM)
		@ 2300 RPM	@ 2800 RPM	@ 3200 RPM	
MG-340**	F: 1.45 / R: 2.13 F: 2.00 / R: 2.13 F: 2.60 / R: 2.13	F: 26(35) / R: 9(12) F: 21(28) / R: 7(9) F: 17(23) / R: 6(8)	F: 26(35) / R: 9(12) F: 26(35) / R: 9(12) F: 21(28) / R: 7(9)	F: 26(35) / R: 9(12) F: 26(35) / R: 9(12) F: 23(31) / R: 8(10)	4500
MG-360**	F: 1.55 / R: 2.00 F: 2.00 / R: 2.00 F: 2.45 / R: 2.45 F: 2.83 / R: 2.45	F: 40(54) / R: 29(39) F: 36(48) / R: 29(39) F: 29(39) / R: 23(31) F: 24(33) / R: 23(31)	F: 50(67) / R: 35(47) F: 44(59) / R: 35(47) F: 35(47) / R: 28(37) F: 29(38) / R: 28(37)	F: 56(75) / R: 40(54) F: 50(67) / R: 40(54) F: 40(54) / R: 32(43) F: 33(44) / R: 32(43)	5000
MG-5005 A	1.54 2.00 2.47	83(111) 67(90) 50(67)	101(136) 82(110) 60(81)	110(148) 93(125) 70(94)	4500
MG-5012 SC	1.51 2.09 2.40 2.77	123(165) 106(142) 94(126) 82(110)	149(200) 129(173) 115(154) 100(134)	171(229) 148(198) 131(176) 114(153)	4500
MG-5020 SC	1.50, 2.04 2.50 2.94	181(242) 145(194) 123(165)	220(295) 176(236) 150(201)	251(337) 201(270) 171(229)	4000
MG-5025 A	1.52, 2.09 2.40	115(154) 100(134)	140(188) 123(165)	160(215) 140(188)	4500
MG-5055 A	1.53, 2.08 2.60	214(287) 144(193)	261(350) 176(236)	298(400) 201(270)	4000
		@ 2300 RPM	@ 2800 RPM	@ 3300 RPM	
MG-5050 SC*	1.00, 1.11, 1.23, 1.53, 1.71, 2.04 2.45 3.00	226(303) 226(303) 200(268)	272(365) 261(350) 231(310)	320(429) 281(377) 261(350)	3300(5500*)
MG-5050 A*	1.12, 1.26, 1.50, 1.80, 2.04 2.50	226(303) 200(268)	272(365) 239(320)	320(429) 259(347)	3300(5500*)
MG-5050 RV*	1.12, 1.26, 1.50, 1.80, 2.04 2.50	226(303) 200(268)	272(365) 239(320)	320(429) 259(347)	3300(5500*)
MG-5061 SC*	1.15, 1.22 , 1.29 , 1.48, 1.77, 2.00 2.43 3.00	283(380) 263(353) 245(329)	345(463) 321(430) 298(400)	395(530) 376(504) 354(475)	3300(5500*)
MG-5061 A*	1.13, 1.28, 1.54, 1.75, 2.00 2.47	283(380) 263(353)	345(463) 321(430)	396(531) 378(507)	3300(5500*)
		@ 2300 RPM	@ 2500 RPM	@ 2800 RPM	
MGX-5065 SC MG-5065 SC	1.08, 1.26, 1.39 , 1.47, 1.72, 2.04 2.43	393(527) 368(493)	425(570) 400(536)	474(636) 448(601)	3600
MGX-5065 A MG-5065 A	1.08, 1.26, 1.47, 1.72, 2.04 2.43	393(527) 368(493)	425(570) 400(536)	474(636) 448(601)	3600
MGX-5075 SC MG-5075 SC	1.06, 1.22, 1.33, 1.49 , 1.53, 1.77, 1.95 , 2.05 2.53 2.88	423(567) 380(510) 373(500)	455(610) 410(550) 403(540)	503(675) 453(607) 434(582)	3500
MG-5075 SC (Step-Up Unit)	0.80, 0.88 , 0.92, 1.00, 1.16	380(510)	410(550)	453(607)	3000
MGX-5075 A MG-5075 A	1.06, 1.22, 1.33, 1.53, 1.77, 2.05 2.53 2.88	423(567) 380(510) 373(500)	455(610) 410(550) 403(540)	503(675) 453(607) 434(582)	3500

Important:
See rating definitions, application information, and torsional compatibility notices on pages 38 and 39.
Ratings shown are in SAE Horsepower (HP). Metric Horsepower equals SAE times 1.014.

* Consult Twin Disc for gasoline engine ratings and required transmission modifications.

**F = Forward Ratios and Ratings; R = Reverse Ratings and Ratios

Bold ratios are available by special order. Contact Twin Disc to confirm availability and lead time.

MODEL	RATIOS	KILOWATTS (HORSEPOWER)			MAXIMUM SPEED (RPM)
		@ 2100 RPM	@ 2300 RPM	@ 2500 RPM	
MG-5082 SC	1.06, 1.11, 1.16, 1.22 , 1.33, 1.46 , 1.53, 1.77, 2.05, 2.28	490 (657)	530 (710)	543 (728)	3200
	2.53	462 (620)	492 (660)	521 (699)	
	2.88	428 (574)	447 (600)	465 (624)	
MG-5082 A	1.06, 1.33, 1.53, 1.77, 2.05, 2.28	490 (657)	530 (710)	543 (728)	3200
	2.53	462 (620)	492 (660)	521 (699)	
	2.88	428 (574)	447 (600)	465 (624)	
MGX-5086 SC	1.06, 1.11, 1.33, 1.53, 1.77, 2.05, 2.28	490 (657)	530 (710)	543 (728)	3200
	2.53	462 (620)	492 (660)	521 (699)	
	2.88	428 (574)	447 (600)	465 (624)	
MGX-5086 A	1.06, 1.33, 1.53, 1.77, 2.05, 2.28	490 (657)	530 (710)	543 (728)	3200
	2.53	462 (620)	492 (660)	521 (699)	
	2.88	428 (574)	447 (600)	465 (624)	
MG-5091 SC	1.17, 1.45, 1.71, 2.04	480 (643)	522 (700)	539 (723)	3000
	2.45	433 (580)	474 (635)	500 (670)	
	2.95	409 (548)	447 (600)	470 (630)	
MGX-5096 A MG-5096 A	1.28, 1.52, 1.81, 2.04	618 (829)	671 (900)	718 (963)	3000
	2.48	556 (746)	596 (800)	638 (856)	
MGX-5114 SC MG-5114 SC	0.93, 1.02, 1.10 , 1.12, 1.24, 1.50, 1.74, 2.04, 2.54	619 (830)	673 (900)	716 (960)	2800 for 0.93:1 3000 for others
	3.00	528 (708)	578 (775)	629 (843)	
MGX-5114 SC-HD MG-5114 SC-HD	1.50, 1.74, 2.04, 2.54	619 (830)	673 (900)	716 (960)	3000
	3.00	528 (708)	578 (775)	629 (843)	
MGX-5114 DC MG-5114 DC	3.28, 3.43, 4.17	619 (830)	673 (900)	701 (940)	3000
	4.59	579 (776)	634 (850)	679 (911)	
	4.86	567 (760)	604 (810)	634 (850)	
MGX-5114 RV MG-5114 RV	1.03, 1.20, 1.48, 1.75, 1.92	619 (830)	673 (900)	701 (940)	3000
	2.04, 2.50				
MGX-5126 A MG-5126 A	1.03, 1.20, 1.48, 1.75, 1.92, 2.04	723 (970)	783 (1050)	816 (1094)	3000
	2.50	621 (933)	673 (902)	701 (940)	
MGX-5136 SC MG-5136 SC	1.00, 1.10, 1.13, 1.24 , 1.28, 1.48, 1.73, 2.04	817 (1096)	895 (1200)	954 (1279)	2800
	2.57	758 (1016)	847 (1136)	901 (1208)	
	2.90	668 (896)	746 (1000)	794 (1065)	
MGX-5136 A MG-5136 A	1.16, 1.25, 1.53, 1.79, 2.00	817 (1096)	895 (1200)	954 (1279)	2800
	2.52	758 (1016)	847 (1136)	901 (1208)	
MGX-5136 RV MG-5136 RV	1.16, 1.25, 1.53, 1.79, 2.00	817 (1096)	895 (1200)	954 (1279)	2800
	2.52	758 (1016)	847 (1136)	901 (1208)	
MGX-5146 SC MG-5146 SC	1.03, 1.08, 1.11	965 (1294)	1045 (1401)	1085 (1455)	2500
	1.20, 1.33, 1.48, 1.57, 1.65 , 1.75, 1.85 , 1.96	1070 (1435)	1142 (1531)	1195 (1603)	
	2.50	875 (1173)	952 (1277)	1001 (1342)	
MGX-5146 A MG-5146 A	1.26, 1.48, 1.75, 1.96	1070 (1435)	1142 (1531)	1195 (1603)	2500
	2.50	931 (1248)	1014 (1360)	1065 (1428)	
MGX-5146 RV MG-5146 RV	1.26, 1.48, 1.75, 1.96	1070 (1435)	1142 (1531)	1195 (1603)	2500
	2.50	931 (1248)	1014 (1360)	1065 (1428)	
MGX-5202 SC MG-5202 SC	1.17, 1.33, 1.53, 1.76, 2.03, 2.48, 2.92	886 (1188)	969 (1300)	1019 (1366)	2750 (2500 at 1.17:1)
	3.48	742 (995)	800 (1073)	841 (1128)	
MGX-5204 SC MG-5204 SC	1.17, 1.33, 1.53, 1.76, 2.03, 2.48, 2.92	1029 (1380)	1104 (1480)	1104 (1480)	2750 (2500 at 1.17:1)
	3.48	984 (1320)	1081 (1450)	1104 (1450)	
MG-6449 A	1.51, 1.73, 2.07, 2.44	1007 (1350)	1104 (1480)	1104 (1480)	2500
	2.95	715 (959)	782 (1050)	782 (1050)	
MG-6449 RV	1.51, 1.73, 2.07, 2.44	1007 (1350)	1104 (1480)	1104 (1480)	2500
	2.95	715 (959)	782 (1050)	782 (1050)	
MGX-6598 DC	2.46, 3.03, 3.48	1335 (1790)	1462 (1961)	1557 (2088)	2500
	3.93	1226 (1644)	1343 (1801)	1399 (1876)	
	4.43	1070 (1435)	1172 (1572)	1249 (1674)	

Important:
See rating definitions, application information, and torsional compatibility notices on pages 38 and 39.
Ratings shown are in SAE Horsepower (HP). Metric Horsepower equals SAE times 1.014.

Bold ratios are available by special order. Contact Twin Disc to confirm availability and lead time.

MODEL	RATIOS	KILOWATTS (HORSEPOWER)			MAXIMUM SPEED (RPM)
		@ 2100 RPM	@ 2300 RPM	@ 2500 RPM	
MGX-6599 SC	1.07, 1.13 , 1.20 , 1.26 , 1.30, 1.32 , 1.39 , 1.50, 1.58 , 1.66 1.74, 1.87 , 1.97, 2.04, 2.19, 2.45 2.82	1326 (1778) 1295 (1737) 1056 (1416)	1452 (1947) 1418 (1902) 1156 (1550)	1518 (2036) 1510 (2024) 1232 (1652)	2500
MGX-6599 A	1.34, 1.51, 1.74, 2.03, 2.24, 2.48, 2.80	1295 (1737)	1418 (1902)	1510 (2024)	2500
MGX-6599 RV	1.34, 1.51, 1.74, 2.03, 2.24, 2.48 2.80	1295 (1737) 1056 (1416)	1418 (1902) 1156 (1550)	1510 (2024) 1232 (1652)	2500
MG-6600 DC	3.30, 4.11, 4.68, 4.72 5.21 6.05	1319 (1769) 1103 (1479) 987 (1324)	1446 (1938) 1208 (1620) 1082 (1450)	1539 (2064) 1287 (1726) 1152 (1545)	2500
MGX-6620 SC	1.15, 1.18 , 1.24 , 1.33, 1.42 , 1.50 , 1.53, 1.56 , 1.60 , 1.65 , 1.71 , 1.73, 1.81 , 2.03, 2.14 , 2.25 , 2.32, 2.44 2.54 , 2.72	1430 (1918) 1342 (1800)	1566 (2100) 1470 (1971)	1668 (2237) 1556 (2087)	2500
MGX-6620 A	1.55, 1.72, 2.09, 2.28, 2.42 2.73	1430 (1918) 1373 (1841)	1566 (2100) 1504 (2017)	1668 (2237) 1602 (2148)	2500
MGX-6620 RV	1.55, 1.72, 2.09, 2.28, 2.42 2.73	1430 (1918) 1357 (1820)	1566 (2100) 1470 (1971)	1668 (2237) 1536 (2060)	2500
MGX-6690 SC MG-6690 SC	1.51, 1.88, 2.03, 2.37 2.47, 2.81, 2.93, 3.21	1534 (2057)	1680 (2253)	1790 (2400)	2300 (1.51-2.03) 2500 (2.37-3.21)
MGX-6848 SC MG-6848 SC	1.51, 1.88, 2.03 2.37, 2.47 2.58, 2.93 3.21	1864 (2500) 1864 (2500) 1746 (2341) 1526 (2046)	2028 (2720) 2028 (2720) 1891 (2536) 1653 (2217)	- 2147 (2879) 2001 (2682) 1748 (2343)	2300 (1.51-2.03) 2500 (2.37-3.21)
MODEL	RATIOS	KILOWATTS (HORSEPOWER)			MAXIMUM SPEED (RPM)
		@ 1600 RPM	@ 1800 RPM	@ 2100 RPM	
MG-6984 SC	1.18, 1.54, 2.06, 2.29, 2.52 2.92 3.25 3.43	1693 (2270) 1648 (2210) 1466 (1966) 1364 (1829)	1905 (2555) 1854 (2486) 1649 (2211) 1534 (2057)	2222 (2980) 2163 (2900) 1924 (2580) 1790 (2400)	2100
MG-6984 A	1.48, 1.97, 2.50 2.79 2.93	1693 (2270) 1682 (2256) 1642 (2202)	1905 (2555) 1892 (2537) 1847 (2477)	2222 (2980) 2207 (2960) 2155 (2890)	2100
MG-6984 RV	1.48, 1.97, 2.50 2.79 2.93	1693 (2270) 1682 (2256) 1642 (2202)	1905 (2555) 1892 (2537) 1847 (2477)	2222 (2980) 2207 (2960) 2155 (2890)	2100
MGX-61000 SC	1.79, 1.84, 1.96, 2.22, 2.54, 2.63, 2.72, 3.03, 3.39	Please contact Twin Disc			2100
MG-61242 SC	1.16, 1.52, 2.08, 2.47 2.96	2176 (2918) 2091 (2804)	2448 (3283) 2353 (3155)	2856 (3830) 2745 (3681)	2100
MG-61242 A	1.42, 2.07, 2.44 2.93	2176 (2918) 2074 (2781)	2448 (3283) 2333 (3129)	2856 (3830) 2722 (3650)	2100
MG-61242 RV	1.42, 2.07, 2.44 2.93	2176 (2918) 2074 (2781)	2448 (3283) 2333 (3129)	2856 (3830) 2722 (3650)	2100
MGX-61500 SC	1.84, 1.98, 2.26, 2.39, 2.45 2.56, 2.86, 2.97, 3.03, 3.41	Please contact Twin Disc			2100

PLEASURE CRAFT RATINGS

MARINE GEARS FOR ELECTRIC & HYBRID PROPULSION

MODEL	RATIOS	KILOWATTS (HORSEPOWER)			MAXIMUM SPEED (RPM)
		@ 2300 RPM	@ 2500 RPM	@ 2800 RPM	
MGE-5065SC	1.47 , 1.72 , 2.04 2.43	393 (527) 368 (493)	425 (570) 400 (536)	474 (636) 448 (601)	3600
MGH-5075SC	1.06, 1.22, 1.33, 1.53, 1.77, 2.05 2.53 2.88	423 (567) 380 (510) 373 (500)	455 (610) 410 (550) 403 (540)	503 (675) 453 (607) 434 (582)	3500
		@ 2100 RPM	@ 2300 RPM	@ 2500 RPM	
MGE-5126SC	1.50 , 1.74 , 2.04, 2.54 3.00	619 (830) 528 (708)	673 (900) 578 (775)	716 (960) 629 (843)	3000
MGE-5204SC	1.53 , 1.76 , 2.03, 2.48 , 2.92 3.48	1029 (1380) 984 (1320)	1104 (1480) 1081 (1450)	1104 (1480) 1081 (1450)	2300

Important:

See rating definitions, application information, and torsional compatibility notices on pages 38 and 39. Ratings shown are in SAE Horsepower (HP). Metric Horsepower equals SAE times 1.014.

Bold ratios are available by special order. Contact Twin Disc to confirm availability and lead time.

MODEL	RATIOS	KILOWATTS (HORSEPOWER)			MAXIMUM SPEED (RPM)
		@ 2300 RPM	@ 2500 RPM	@ 2800 RPM	
MG-5050 SC*	1.00, 1.11, 1.23, 1.53, 1.71, 2.04 2.45 3.00	211(283) 211(283) 187(251)	228(306) 216(290) 198(266)	254(341) 223(299) 216(290)	3300(5500*)
MG-5050 A*	1.12, 1.26, 1.50, 1.80, 2.04 2.50	211(283) 187(251)	228(306) 204(274)	254(341) 223(299)	3300(5500*)
MG-5050 RV*	1.12, 1.26, 1.50, 1.80, 2.04 2.50	211(283) 187(251)	228(306) 204(274)	254(341) 223(299)	3300(5500*)
MG-5061 SC*	1.15, 1.22 , 1.29 , 1.48, 1.77, 2.00 2.43 3.00	265(355) 246(330) 229(307)	288(386) 268(360) 248(333)	323(433) 300(402) 279(374)	3300(5500*)
MG-5061 A*	1.13, 1.28, 1.54, 1.75 2.00, 2.47	257(345) 246(330)	281(377) 268(360)	313(420) 300(402)	3300(5500*)
MGX-5065 SC MG-5065 SC	1.08, 1.26, 1.39 , 1.47, 1.72, 2.04 2.43	376(504) 351(471)	407(546) 381(511)	453(607) 428(574)	3600
MGX-5065 A MG-5065 A	1.08, 1.26, 1.47, 1.72, 2.04 2.43	376(504) 351(471)	407(546) 381(511)	453(607) 428(574)	3600
MGX-5075 SC MG-5075 SC	1.06, 1.22, 1.33, 1.49 , 1.53, 1.77, 1.95 , 2.05 2.53 2.88	368(493) 355(476) 348(467)	390(523) 383(514) 375(503)	433(581) 423(567) 406(544)	3500
MG-5075 SC (Step-Up Unit)	0.80, 0.88 , 0.92, 1.00, 1.16	355(476)	383(514)	423(567)	3000
MGX-5075 A MG-5075 A	1.06, 1.22, 1.33, 1.53, 1.77, 2.05 2.53 2.88	368(493) 355(476) 348(467)	390(523) 383(514) 375(503)	433(581) 423(567) 406(544)	3500
		@ 2100 RPM	@ 2300 RPM	@ 2500 RPM	
MG-5082 SC	1.06, 1.11, 1.16 , 1.22 , 1.33, 1.46 , 1.53, 1.77, 2.05, 2.28, 2.53 2.88	432(579) 400(536)	460(617) 418(560)	487(653) 434(582)	3200
MG-5082 A	1.06, 1.33, 1.53, 1.77, 2.05, 2.28, 2.53 2.88	432(579) 400(536)	460(617) 418(560)	487(653) 434(582)	3200
MGX-5086 SC	1.06, 1.11, 1.33, 1.53, 1.77, 2.05, 2.28, 2.53 2.88	432(579) 400(536)	460(617) 418(560)	487(653) 434(582)	3200
MGX-5086 A	1.06, 1.33, 1.53, 1.77, 2.05, 2.28, 2.53 2.88	432(579) 400(536)	460(617) 418(560)	487(653) 434(582)	3200
MG-5091 SC	1.17, 1.45, 1.71, 2.04 2.45 2.95	429(575) 404(542) 382(512)	471(632) 442(593) 418(561)	495(664) 467(626) 439(589)	3000
MGX-5096A MG-5096A	1.28, 1.52, 1.81, 2.04 2.48	560(751) 520(697)	597(801) 559(750)	633(849) 598(802)	3000
MGX-5114 SC MG-5114 SC	0.93, 1.02, 1.10 , 1.12, 1.24, 1.50, 1.74, 2.04, 2.54 3.00	579(776) 494(662)	629(843) 540(724)	669(897) 588(789)	2800 at .93:1 3000 for others
MGX-5114 SC-HD MG-5114 SC-HD	1.50, 1.74, 2.04, 2.54 3.00	579(776) 494(662)	629(843) 540(724)	669(897) 588(789)	3000
MGX-5114 DC MG-5114 DC	3.28, 3.43, 4.17 4.59 4.86	579(776) 542(727) 530(711)	629(843) 591(793) 565(758)	656(880) 634(850) 575(771)	3000
MGX-5114 RV MG-5114 RV	1.03, 1.20, 1.48, 1.75, 1.92 2.04, 2.50	580(777)	629(843)	655(878)	3000
MGX-5126 A MG-5126 A	1.03, 1.20, 1.48, 1.75, 1.92, 2.04 2.50	675(905) 580(778)	732(982) 629(843)	763(1023) 656(880)	3000

Important:
See rating definitions, application information, and torsional compatibility notices on pages 38 and 39.
Ratings shown are in SAE Horsepower (HP). Metric Horsepower equals SAE times 1.014.

* Consult Twin Disc for gasoline engine ratings and required transmission modifications.
Bold ratios are available by special order. Contact Twin Disc to confirm availability and lead time.

LIGHT DUTY RATINGS

STANDARD & QUICKSHIFT
MARINE TRANSMISSIONS



MODEL	RATIOS	KILOWATTS (HORSEPOWER)			MAXIMUM SPEED (RPM)
		@ 2100 RPM	@ 2300 RPM	@ 2500 RPM	
MGX-5136 SC MG-5136 SC	1.00, 1.10, 1.13, 1.24 , 1.28, 1.48, 1.73, 2.04 2.57 2.90	704 (944) 663 (889) 622 (834)	746 (1000) 716 (960) 671 (900)	788 (1057) 768 (1030) 720 (966)	2800
MGX-5136 A MG-5136 A	1.16, 1.25, 1.53, 1.79, 2.00 2.52	704 (944) 663 (889)	746 (1000) 716 (960)	788 (1057) 768 (1030)	2800
MGX-5136 RV MG-5136 RV	1.16, 1.25, 1.53, 1.79, 2.00 2.52	704 (944) 663 (889)	746 (1000) 716 (960)	788 (1057) 768 (1030)	2800
MGX-5146 SC MG-5146 SC	1.03, 1.08, 1.11 1.20, 1.33, 1.48, 1.57, 1.65 , 1.75, 1.85 , 1.96 2.50	781 (1047) 918 (1231) 828 (1110)	846 (1134) 974 (1306) 895 (1200)	878 (1177) 1028 (1379) 961 (1289)	2500
MGX-5146 A MG-5146 A	1.26, 1.48, 1.75, 1.96 2.50	918 (1231) 828 (1110)	974 (1306) 895 (1200)	1028 (1379) 961 (1289)	2500
MGX-5146 RV MG-5146 RV	1.26, 1.48, 1.75, 1.96 2.50	918 (1231) 828 (1110)	974 (1306) 895 (1200)	1028 (1379) 961 (1289)	2500
		@ 1800 RPM	@ 2100 RPM	@ 2300 RPM	
MGX-5202 SC MG-5202 SC	1.17, 1.33, 1.53, 1.76, 2.03, 2.48, 2.92 3.48	742 (995) 641 (860)	852 (1142) 731 (980)	924 (1239) 789 (1059)	2750
MGX-5204 SC MG-5204 SC	1.17, 1.33, 1.53, 1.76, 2.03, 2.48, 2.92 3.48	742 (995) 647 (868)	865 (1160) 764 (1025)	979 (1313) 837 (1122)	2750
MG-6449 A	1.51, 1.73 2.07 2.44 2.95	840 (1126) 795 (1067) 711 (953) 545 (731)	978 (1312) 912 (1223) 805 (1080) 635 (852)	1072 (1437) 974 (1306) 861 (1154) 696 (933)	2500
MG-6449 RV	1.51, 1.73 2.07 2.44 2.95	840 (1126) 795 (1067) 711 (953) 545 (731)	978 (1312) 912 (1223) 805 (1080) 635 (852)	1072 (1437) 974 (1306) 861 (1154) 696 (933)	2500
MGX-6598 DC	2.46, 3.03 3.48 3.93 4.43	1000 (1341) 1000 (1341) 952 (1277) 862 (1156)	1167 (1565) 1155 (1549) 1060 (1421) 990 (1328)	1278 (1714) 1241 (1664) 1131 (1517) 1055 (1415)	2500
MGX-6599 SC	1.07, 1.13, 1.20, 1.26 , 1.30, 1.32, 1.39 , 1.50, 1.58 , 1.66, 1.74 1.87 , 1.97, 2.04, 2.19 2.45 2.82	1010 (1354) 1001 (1342) 920 (1234) 821 (1101)	1178 (1580) 1167 (1565) 1073 (1439) 955 (1281)	1244 (1668) 1234 (1655) 1164 (1561) 1042 (1397)	2500
MGX-6599 A	1.34, 1.51, 1.74, 2.03, 2.24 2.48 2.80	1092 (1464) 935 (1254) 896 (1202)	1221 (1637) 1091 (1463) 1045 (1401)	1301 (1745) 1195 (1602) 1144 (1534)	2500
MGX-6599 RV	1.34, 1.51, 1.74, 2.03, 2.24 2.48 2.80	1092 (1464) 935 (1254) 896 (1202)	1221 (1637) 1091 (1463) 1045 (1401)	1301 (1745) 1195 (1602) 1144 (1534)	2500
MG-6600 DC	3.30, 4.11 4.68, 4.72 5.22 6.05	1009 (1353) 926 (1242) 818 (1097) 722 (968)	1177 (1578) 1080 (1448) 953 (1278) 843 (1129)	1289 (1728) 1182 (1585) 1044 (1400) 923 (1237)	2500
MGX-6620 SC	1.15, 1.18, 1.24 1.33, 1.42, 1.50 , 1.53, 1.56, 1.60, 1.65, 1.71 , 1.73, 1.81 , 2.03, 2.14, 2.25 , 2.32, 2.44 2.54 , 2.72	1109 (1487) 1109 (1487) 1080 (1448)	1294 (1735) 1294 (1735) 1255 (1683)	1338 (1794) 1417 (1900) 1338 (1794)	2500
MGX-6620 A	1.55, 1.72, 2.09, 2.28, 2.42 2.73	1106 (1483) 1105 (1482)	1294 (1735) 1248 (1674)	1417 (1900) 1330 (1784)	2500
MGX-6620 RV	1.55, 1.72 2.09, 2.28, 2.42 2.73	1122 (1505) 1122 (1505) 1030 (1381)	1309 (1755) 1262 (1692) 1147 (1538)	1434 (1923) 1345 (1804) 1223 (1640)	2500

Important:

See rating definitions, application information, and torsional compatibility notices on pages 38 and 39. Ratings shown are in SAE Horsepower (HP). Metric Horsepower equals SAE times 1.014.

Bold ratios are available by special order. Contact Twin Disc to confirm availability and lead time.

LIGHT DUTY RATINGS

STANDARD & QUICKSHIFT
MARINE TRANSMISSIONS



MODEL	RATIOS	KILOWATTS (HORSEPOWER)			MAXIMUM SPEED (RPM)
		@ 1800 RPM	@ 2100 RPM	@ 2300 RPM	
MGX-6690 SC MG-6690 SC	1.51, 1.88, 2.03, 2.37 2.47, 2.81, 2.93, 3.21	1225 (1643)	1417 (1900)	1464 (1963)	2300 (1.51-2.03) 2500 (2.37-3.21)
MGX-6848 SC MG-6848 SC	1.51, 1.88, 2.03, 2.37, 2.47 2.58, 2.81, 2.93 3.21	1591 (2134) 1483 (1989) 1297 (1739)	1828 (2451) 1699 (2278) 1485 (1991)	1985 (2662) 1841 (2469) 1609 (2158)	2300 (1.51-2.03) 2500 (2.37-3.21)
		@ 1600 RPM	@ 1800 RPM	@ 2100 RPM	
MG-6984 SC	1.18, 1.54, 2.06, 2.29, 2.52 2.92 3.25 3.43	1614 (2164) 1528 (2049) 1269 (1702) 1180 (1582)	1816 (2435) 1719 (2305) 1427 (1914) 1328 (1781)	2119 (2842) 2006 (2690) 1665 (2233) 1549 (2077)	2100
MG-6984 A	1.48, 1.97 2.50 2.79 2.93	1602 (2148) 1552 (2081) 1536 (2060) 1512 (2028)	1802 (2416) 1746 (2341) 1728 (2317) 1701 (2281)	2102 (2819) 2037 (2732) 2016 (2703) 1984 (2661)	2100
MG-6984 RV	1.48, 1.97 2.50 2.79 2.93	1602 (2148) 1552 (2081) 1536 (2060) 1512 (2028)	1802 (2416) 1746 (2341) 1728 (2317) 1701 (2281)	2102 (2819) 2037 (2732) 2016 (2703) 1984 (2661)	2100
MGX-61000 SC	1.79, 1.84, 1.96, 2.22, 2.54, 2.63, 2.72, 3.03, 3.39	Please contact Twin Disc			2100
MG-61242 SC	1.16, 1.52, 2.08 2.47 2.96	2064 (2768) 2007 (2691) 1950 (2615)	2322 (3114) 2258 (3028) 2193 (2941)	2709 (3633) 2634 (3532) 2559 (3432)	2100
MG-61242 A	1.42, 2.07 2.44 2.93	2090 (2803) 2007 (2691) 1950 (2615)	2351 (3153) 2258 (3028) 2193 (2941)	2743 (3678) 2634 (3532) 2559 (3432)	2100
MG-61242 RV	1.42, 2.07 2.44 2.93	2090 (2803) 2007 (2691) 1950 (2615)	2351 (3153) 2258 (3028) 2193 (2941)	2743 (3678) 2634 (3532) 2559 (3432)	2100
MGX-61500 SC	1.84, 1.98, 2.26, 2.39, 2.45 2.56, 2.86, 2.97, 3.03, 3.41	Please contact Twin Disc			2100

LIGHT DUTY RATINGS

MARINE GEARS FOR ELECTRIC & HYBRID PROPULSION

MODEL	RATIOS	KILOWATTS (HORSEPOWER)			MAXIMUM SPEED (RPM)
		@ 2300 RPM	@ 2500 RPM	@ 2800 RPM	
MGE-5065SC	1.47, 1.72 , 2.04 2.43	376 (504) 351 (471)	407 (546) 381 (511)	453 (607) 428 (574)	3600
MGH-5075SC	1.06, 1.22, 1.33, 1.53, 1.77, 2.05 2.53 2.88	368 (493) 355 (476) 348 (467)	390 (523) 383 (514) 375 (503)	433 (581) 423 (567) 406 (544)	3500
		@ 2100 RPM	@ 2300 RPM	@ 2500 RPM	
MGE-5126SC	1.50, 1.74 , 2.04, 2.54 3.00	579 (776) 494 (662)	629 (843) 540 (724)	716 (960) 629 (843)	3000
		@ 1800 RPM	@ 2100 RPM	@ 2300 RPM	
MGE-5204SC	1.53, 1.76 , 2.03, 2.48 , 2.92 3.48	742 (995) 647 (868)	865 (1160) 764 (1025)	979 (1313) 837 (1122)	2300

Important:
See rating definitions, application information, and torsional compatibility notices on pages 38 and 39.
Ratings shown are in SAE Horsepower (HP). Metric Horsepower equals SAE times 1.014.

Bold ratios are available by special order. Contact Twin Disc to confirm availability and lead time.

MODEL	RATIOS	KILOWATTS (HORSEPOWER)			MAXIMUM SPEED (RPM)
		@ 2100 RPM	@ 2500 RPM	@ 2800 RPM	
MG-340**	F: 1.45 / R: 2.13 F: 2.00 / R: 2.13 F: 2.60 / R: 2.13	F: 24 (32) / R: 8 (10) F: 17 (23) / R: 6 (8) F: 13 (17) / R: 4 (6)	F: 26 (35) / R: 9 (12) F: 20 (27) / R: 7 (9) F: 15 (20) / R: 5 (7)	F: 26 (35) / R: 9 (12) F: 23 (31) / R: 8 (10) F: 18 (24) / R: 6 (8)	4500
MG-360**	F: 1.55 / R: 2.00 F: 2.00 / R: 2.00 F: 2.45 / R: 2.45 F: 2.83 / R: 2.45	F: 31(42) / R: 22(30) F: 28(38) / R: 22(30) F: 23(31) / R: 18(25) F: 19(26) / R: 18(25)	F: 36 (48) / R: 26 (35) F: 33 (44) / R: 26 (35) F: 29 (39) / R: 22 (30) F: 22 (30) / R: 22 (30)	F: 41 (55) / R: 30 (40) F: 37 (50) / R: 30 (40) F: 31 (42) / R: 25 (33) F: 25 (33) / R: 25 (33)	5000
MG-5005 A	1.54, 2.00 2.47	47 (63) 35 (47)	56 (75) 41 (55)	63 (85) 47 (63)	4500
MG-5012 SC	1.51 2.09 2.40 2.78	93 (124) 81 (108) 72 (96) 62 (84)	110 (148) 96 (129) 85 (115) 74 (100)	124 (166) 108 (144) 96 (128) 83 (111)	4500
MG-5020 SC	1.50, 2.04 2.50 2.94	134 (179) 107 (144) 93 (124)	159 (214) 143 (192) 110 (148)	178 (239) 143 (192) 124 (166)	4000
MG-5025 A	1.52, 2.09 2.40	81 (109) 69 (93)	97 (130) 82 (110)	108 (145) 92 (123)	4500
MG-5055 A	1.53, 2.08 2.60	147 (197) 99 (135)	175 (235) 118 (160)	196 (263) 132 (179)	4000
MG-5050 SC	1.00, 1.11, 1.23, 1.53, 1.71, 2.04, 2.45 3.00	157 (211) 142 (190)	187 (251) 170 (228)	209 (280) 194 (260)	3300
MG-5050 A	1.12, 1.26, 1.50, 1.80, 2.04, 2.50	157 (211)	187 (251)	209 (280)	3300
MG-5050 RV	1.12, 1.26, 1.50, 1.80, 2.04, 2.50	157 (211)	187 (251)	209 (280)	3300
MG-5061 SC	1.15, 1.22, 1.29 , 1.48, 1.77, 2.00, 2.43, 3.00	201 (270)	239 (320)	261 (350)	3300
MG-5061 A	1.13, 1.28, 1.54, 1.75, 2.00, 2.47	201 (270)	239 (320)	261 (350)	3300
MGX-5065 SC	1.08, 1.26, 1.39 , 1.47, 1.72, 2.04	279 (374)	329 (441)	367 (492)	3600
MG-5065 SC	2.43	254 (341)	302 (405)	338 (453)	
MGX-5065 A	1.08, 1.26, 1.47, 1.72, 2.04	279 (374)	329 (441)	367 (492)	3600
MG-5065 A	2.43	254 (341)	302 (405)	338 (453)	
MGX-5075 SC	1.06, 1.22, 1.33, 1.49 , 1.53, 1.77, 1.95 , 2.05	283 (380)	310 (416)	324 (434)	3500
MG-5075 SC	2.53	268 (360)	298 (400)	313 (420)	
	2.88	261 (350)	287 (385)	306 (410)	
MG-5075 SC (Step-Up Unit)	0.80, 0.88 , 0.92, 1.00, 1.16	268 (360)	298 (400)	313 (420)	3000
MGX-5075 A	1.06, 1.22, 1.33, 1.53, 1.77, 2.05	283 (380)	310 (416)	324 (434)	3500
MG-5075 A	2.53	268 (360)	298 (400)	313 (420)	
	2.88	261 (350)	287 (385)	306 (410)	
MG-5082 SC	1.06, 1.11, 1.16, 1.22 , 1.33, 1.46 , 1.53, 1.77, 2.05, 2.28, 2.53 2.88	351 (471) 340 (456)	396 (531) 384 (515)	428 (574) 415 (557)	3200
MG-5082 A	1.06, 1.33, 1.53, 1.77, 2.05, 2.28, 2.53 2.88	351 (471) 340 (456)	396 (531) 384 (515)	428 (574) 415 (557)	3200

Important:
See rating definitions, application information, and torsional compatibility notices on pages 38 and 39.
Ratings shown are in SAE Horsepower (HP). Metric Horsepower equals SAE times 1.014.

**F = Forward Ratios and Ratings; R = Reverse Ratings and Ratios
Bold ratios are available by special order. Contact Twin Disc to confirm availability and lead time.

MODEL	RATIOS	KILOWATTS (HORSEPOWER)			MAXIMUM SPEED (RPM)
		@ 2100 RPM	@ 2500 RPM	@ 2800 RPM	
MGX-5086 SC	1.06, 1.11, 1.33, 1.53, 1.77, 2.05, 2.28, 2.53 2.88	351 (471) 340 (456)	396 (531) 384 (515)	428 (574) 415 (557)	3200
MGX-5086 A	1.06, 1.33, 1.53, 1.77, 2.05, 2.28, 2.53 2.88	351 (471) 340 (456)	396 (531) 384 (515)	428 (574) 415 (557)	3200
MG-5091 SC	1.17, 1.45, 1.71, 2.04 2.45, 2.95 3.33	354 (475) 336 (450) 268 (360)	403 (540) 374 (501) 309 (415)	425 (570) 403 (540) 346 (464)	3000
MG-5091 DC	3.82 4.50 5.05	321 (431) 298 (400) 251 (336)	377 (506) 350 (470) 298 (400)	420 (563) 384 (515) 334 (448)	3000
		@ 1800 RPM	@ 2100 RPM	@ 2300 RPM	
MGX-5096 A MG-5096 A	1.28, 1.52, 1.81, 2.04 2.48	367 (492) 336 (451)	410 (550) 380 (510)	438 (587) 409 (548)	3000
MGX-5114 SC MG-5114 SC	0.93, 1.02, 1.10 , 1.12, 1.24, 1.50, 1.74, 2.04 2.54 3.00	448 (601) 410 (550) 380 (510)	504 (676) 466 (625) 451 (605)	552 (740) 500 (671) 492 (660)	2800 at .93:1 3000 for others
MGX-5114 SC-HD MG-5114 SC-HD	1.50, 1.74, 2.04 2.54 3.00	448 (601) 410 (550) 380 (510)	504 (676) 466 (625) 451 (605)	552 (740) 500 (671) 492 (660)	3000
MGX-5114 DC MG-5114 DC	3.28, 3.43, 4.17 4.59 4.86	431 (580) 388 (520) 375 (503)	504 (676) 448 (601) 429 (575)	537 (720) 477 (640) 463 (621)	3000
MGX-5114 RV MG-5114 RV	1.03, 1.20, 1.48, 1.75, 1.92, 2.04 2.50	404 (542) 351 (471)	466 (625) 400 (536)	504 (676) 433 (581)	3000
MGX-5126 A MG-5126 A	1.03, 1.20, 1.48, 1.75, 1.92, 2.04 2.50	404 (542) 351 (471)	466 (625) 400 (536)	504 (676) 433 (581)	3000
MGX-5136 SC MG-5136 SC	1.00, 1.10, 1.13 , 1.24 , 1.28, 1.48, 1.73, 2.04, 2.57 2.90	529 (709) 493 (661)	560 (751) 522 (700)	600 (805) 560 (751)	2800
MGX-5136 A MG-5136 A	1.16, 1.25, 1.53, 1.79, 2.00, 2.52	529 (709)	560 (751)	600 (805)	2800
MGX-5136 RV MG-5136 RV	1.16, 1.25, 1.53, 1.79, 2.00, 2.52	529 (709)	560 (751)	600 (805)	2800
MGX-5146 SC MG-5146 SC	1.03, 1.08 , 1.11 1.20, 1.33, 1.48, 1.57, 1.65 , 1.75, 1.85 , 1.96 2.50	661 (886) 753 (1010) 615 (825)	758 (1016) 806 (1081) 702 (941)	821 (1101) 903 (1211) 760 (1019)	2500
MGX-5146 A MG-5146 A	1.26, 1.48, 1.75, 1.96 2.50	753 (1010) 615 (825)	806 (1081) 702 (941)	903 (1211) 760 (1019)	2500
MGX-5146 RV MG-5146 RV	1.26, 1.48, 1.75, 1.96 2.50	753 (1010) 615 (825)	806 (1081) 702 (941)	903 (1211) 760 (1019)	2500
MGX-516 MG-516	3.06 3.50 4.04 4.52 5.05 6.00	530 (711) 518 (695) 494 (662) 484 (649) 468 (628) 419 (562)	573 (768) 549 (736) 521 (699) 510 (684) 492 (660) 470 (630)	594 (797) 569 (763) 540 (724) 526 (705) 508 (681) 498 (668)	2500
MGX-5170 DC MG-5170 DC	3.12, 3.54, 4.06, 4.50, 5.03, 5.95 6.53, 6.95	537 (720) 467 (626)	578 (775) 545 (731)	578 (775) 561 (752)	2500
MGX-5202 SC MG-5202 SC	1.17, 1.33, 1.53, 1.76, 2.03, 2.48, 2.92 3.48	630 (845)	720 (966)	778 (1043)	2750 (2500 at 1.17:1)

Important:
See rating definitions, application information, and torsional compatibility notices on pages 38 and 39.
Ratings shown are in SAE Horsepower (HP). Metric Horsepower equals SAE times 1.014.

Bold ratios are available by special order. Contact Twin Disc to confirm availability and lead time.

MODEL	RATIOS	KILOWATTS (HORSEPOWER)			MAXIMUM SPEED (RPM)	
		@ 1800 RPM	@ 2100 RPM	@ 2300 RPM		
MGX-5204 SC MG-5204 SC	1.17, 1.33, 1.53, 1.76, 2.03, 2.48, 2.92 3.48	727 (975) 630 (845)	858 (1151) 720 (966)	969 (1299) 781 (1047)	2750 (2500 at 1.17:1)	
MGX-5222 DC MG-5222 DC	4.03, 4.59, 5.04, 5.57, 6.10, 6.55, 6.96	630 (845)	720 (966)	778 (1043)	2500	
MGX-5225 DC MG-5225 DC	4.03, 4.59, 5.04, 5.57, 6.10	727 (975)	858 (1151)	869 (1165)	2500	
MGX-5321 DC MG-5321 DC	3.35, 4.06, 4.42, 4.96, 5.46, 5.96 6.39	1044 (1400) 893 (1198)	1163 (1560) 1022 (1371)	1178 (1580) 1108 (1486)	2400	
		@ 1600 RPM	@ 1800 RPM	@ 2100 RPM		
MG-540 (with flexible coupling)	1.93, 2.58, 2.90, 3.26	1049 (1407) 893 (1198)	1180 (1582) 1011 (1356)	— 1193 (1600)	1900 2400	
	3.91	1049 (1407)	1180 (1582)	—	1900	
	4.10, 4.60	1038 (1392)	1168 (1566)	1362 (1826)	2100	
	5.17	867 (1163)	975 (1307)	1138 (1526)	2400	
	6.18	766 (1027)	861 (1155)	1005 (1348)	2400	
	7.00	718 (963)	808 (1084)	943 (1265)	2400	
	7.47					
MG-5506	4.03, 4.55, 4.96, 5.44 6.00	1323 (1774) 1197 (1605)	1489 (1998) 1347 (1806)	— —	2000	
MGX-5600 MG-5600	2.53, 2.98, 3.51, 4.03 4.63, 5.04 5.76 6.04	1602 (2148) 1602 (2148) 1598 (2143) 1353 (1814)	1805 (2421) 1805 (2421) 1760 (2360) 1502 (2014)	2105 (2823) 2095 (2809) 1770 (2374) 1717 (2302)	2100	
		@ 1800 RPM	@ 2100 RPM	@ 2300 RPM		
MG-6449 A	1.51, 1.73	769 (1031)	897 (1203)	958 (1285)	2500	
	2.07	639 (857)	746 (1000)	794 (1065)		
	2.44	555 (744)	647 (868)	692 (928)		
	2.95	496 (665)	577 (774)	617 (828)		
MG-6449 RV	1.51, 1.73	769 (1031)	897 (1203)	958 (1285)	2500	
	2.07	639 (857)	746 (1000)	794 (1065)		
	2.44	555 (744)	647 (868)	692 (928)		
	2.95	496 (665)	577 (774)	617 (828)		
MGX-6598 DC	2.46, 3.03	882 (1183)	1000 (1341)	1067 (1431)	2500	
	3.48	849 (1139)	945 (1267)	1008 (1352)		
	3.93	774 (1038)	861 (1155)	918 (1231)		
	4.43	722 (968)	804 (1078)	857 (1149)		
MGX-6599 SC	1.07, 1.13 , 1.20 , 1.26 , 1.30, 1.32 , 1.39 , 1.50, 1.58 , 1.66, 1.74, 1.87 , 1.97, 2.04 2.19, 2.45 2.82	862 (1156) 844 (1132) 728 (976)	960 (1287) 940 (1261) 811 (1088)	1023 (1372) 1002 (1344) 864 (1159)	2500	
	MGX-6599 A	1.34, 1.51, 1.74, 2.03, 2.24	890 (1193)	992 (1330)	1057 (1417)	2500
		2.48	841 (1128)	937 (1257)	999 (1340)	
		2.80	815 (1093)	908 (1218)	967 (1297)	
MGX-6599 RV	1.34, 1.51, 1.74, 2.03, 2.24	890 (1193)	992 (1330)	1057 (1417)	2500	
	2.48	841 (1128)	937 (1257)	999 (1340)		
	2.80	815 (1093)	908 (1218)	967 (1297)		
MG-6600 DC	3.30	819 (1098)	955 (1281)	1046 (1403)	2500	
	4.11	819 (1098)	955 (1281)	1018 (1365)		
	4.68, 4.72	777 (1042)	906 (1215)	966 (1295)		
	5.21	693 (929)	809 (1085)	886 (1188)		
	6.05	617 (828)	719 (964)	788 (1057)		

Important:
See rating definitions, application information, and torsional compatibility notices on pages 38 and 39.
Ratings shown are in SAE Horsepower (HP). Metric Horsepower equals SAE times 1.014.

Bold ratios are available by special order. Contact Twin Disc to confirm availability and lead time.

MODEL	RATIOS	KILOWATTS (HORSEPOWER)			MAXIMUM SPEED (RPM)
		@ 1800 RPM	@ 2100 RPM	@ 2300 RPM	
MGX-6620 SC	1.15, 1.18 , 1.24 , 1.33, 1.42 , 1.50 , 1.53, 1.56 , 1.60 , 1.65 , 1.71 , 1.73 1.81 , 2.03 2.14 , 2.25 , 2.32 2.44 2.54 , 2.72	1047 (1404)	1166 (1564)	1191 (1597)	2500
		1025 (1375)	1142 (1531)	1184 (1588)	
		1019 (1366)	1136 (1523)	1184 (1588)	
		987 (1324)	1100 (1475)	1172 (1572)	
		915 (1227)	1019 (1366)	1086 (1456)	
MGX-6620 A	1.55, 1.72, 2.09 2.28, 2.42 2.73	1103 (1479)	1234 (1655)	1315 (1763)	2500
		1028 (1379)	1145 (1535)	1220 (1636)	
		910 (1220)	1014 (1360)	1080 (1448)	
MGX-6620 RV	1.55 1.72 2.09 2.28, 2.42 2.73	1031 (1383)	1149 (1541)	1224 (1641)	2500
		998 (1338)	1112 (1491)	1185 (1589)	
		947 (1270)	1055 (1415)	1125 (1509)	
		920 (1234)	1025 (1375)	1092 (1464)	
		836 (1121)	932 (1250)	993 (1332)	
MGX-6690 SC MG-6690 SC	1.51, 1.88, 2.03, 2.37, 2.47 2.81, 2.93 3.21	1201 (1611)	1380 (1851)	1438 (1928)	2300 (1.51-2.03) 2500 (2.37-3.21)
		1201 (1611)	1318 (1767)	1386 (1859)	
MGX-6848 SC MG-6848 SC	1.51, 1.88, 2.03, 2.37, 2.47, 2.58, 2.81, 2.93 3.21	1342 (1800)	1566 (2100)	1715 (2300)	2300 (1.51-2.03) 2500 (2.37-3.21)
		1269 (1702)	1453 (1948)	1575 (2112)	
		@ 1600 RPM	@ 1800 RPM	@ 2100 RPM	
MG-6984 SC	1.18, 1.54, 2.06, 2.29, 2.52, 2.92 3.25 3.43	1470 (1971)	1654 (2218)	1929 (2587)	2100
		1244 (1668)	1399 (1876)	1632 (2189)	
		1000 (1341)	1125 (1509)	1313 (1761)	
MG-6984 A	1.48, 1.97, 2.50, 2.79 2.93	1504 (2017)	1692 (2269)	1974 (2647)	2100
		1462 (1961)	1645 (2206)	1919 (2573)	
MG-6984 RV	1.48, 1.97, 2.50, 2.79 2.93	1504 (2017)	1692 (2269)	1974 (2647)	2100
		1462 (1961)	1645 (2206)	1919 (2573)	
MGX-61000 SC	1.79, 1.84, 1.96, 2.22, 2.54, 2.63, 2.72, 3.03, 3.39	Please contact Twin Disc			2100
MG-61242 SC	1.16, 1.52, 2.08 2.47 2.96	2001 (2683)	2251 (3019)	2626 (3521)	2100
		1960 (2628)	2205 (2957)	2571 (3448)	
		1949 (2614)	2193 (2941)	2559 (3432)	
MG-61242 A	1.42, 2.07 2.44, 2.93	2078 (2787)	2338 (3135)	2728 (3658)	2100
		1949 (2614)	2193 (2941)	2559 (3432)	
MG-61242 RV	1.42, 2.07 2.44, 2.93	2078 (2787)	2338 (3135)	2728 (3658)	2100
		1949 (2614)	2193 (2941)	2559 (3432)	
MGX-61500 SC	1.84, 1.98, 2.26, 2.39, 2.45 2.56, 2.86, 2.97, 3.03, 3.41	Please contact Twin Disc			2100
MGX-61500SC-HL/HR	1.84, 1.98, 2.18, 2.26, 2.56, 2.97	Please contact Twin Disc			2100

INTERMEDIATE DUTY RATINGS

MARINE GEARS FOR ELECTRIC & HYBRID PROPULSION

MODEL	RATIOS	KILOWATTS (HORSEPOWER)			MAXIMUM SPEED (RPM)
		@ 2100 RPM	@ 2500 RPM	@ 2800 RPM	
MGE-5065SC	1.47 , 1.72 , 2.04 2.43	279 (374)	329 (441)	367 (492)	3600
		254 (341)	302 (405)	338 (453)	
MGH-5075SC	1.06, 1.22, 1.33, 1.53, 1.77, 2.05 2.53 2.88	283 (380)	310 (416)	324 (434)	3500
		268 (360)	298 (400)	313 (420)	
		261 (350)	287 (385)	306 (410)	
		@ 1800 RPM	@ 2100 RPM	@ 2300 RPM	
MGE-5126SC	1.50 , 1.74 , 2.04 2.54 3.00	448 (601)	504 (676)	552 (740)	3000
		410 (550)	466 (625)	500 (671)	
		380 (510)	451 (605)	492 (660)	
MGE-5204SC	1.53 , 1.76 , 2.03, 2.48, 2.92 3.48	727 (975)	858 (1151)	969 (1299)	2300
		630 (845)	720 (966)	781 (1047)	

Important:
See rating definitions, application information, and torsional compatibility notices on pages 38 and 39.
Ratings shown are in SAE Horsepower (HP). Metric Horsepower equals SAE times 1.014.

Bold ratios are available by special order. Contact Twin Disc to confirm availability and lead time.

MODEL	RATIOS	KILOWATTS (HORSEPOWER)			MAXIMUM SPEED (RPM)
		@ 1800 RPM	@ 2100 RPM	@ 2300 RPM	
MG-5050 SC	1.00, 1.11, 1.23, 1.53, 1.71, 2.04, 2.45 3.00	115 (154) 102 (137)	128 (172) 119 (160)	140 (188) 133 (178)	3300
MG-5050 A	1.12, 1.26, 1.50, 1.80, 2.04, 2.50	115 (154)	128 (172)	140 (188)	3300
MG-5050 RV	1.12, 1.26, 1.50, 1.80, 2.04, 2.50	115 (154)	128 (172)	140 (188)	3300
MG-5061 SC	1.15, 1.22, 1.29 , 1.48, 1.77, 2.00, 2.43 3.00	135 (181) 126 (169)	157 (211) 147 (197)	171 (229) 160 (215)	3300
MG-5061 A	1.13, 1.28, 1.54, 1.75, 2.00 2.47	135 (181) 126 (169)	157 (211) 147 (197)	171 (229) 160 (215)	3300
MGX-5065 SC	1.08, 1.26, 1.39 , 1.47, 1.72, 2.04 2.43	227 (304) 208 (279)	262 (351) 243 (326)	285 (382) 266 (357)	3600
MGX-5065 A	1.08, 1.26, 1.47, 1.72, 2.04 2.43	227 (304) 208 (279)	262 (351) 243 (326)	285 (382) 266 (357)	3600
MGX-5075 SC	1.06, 1.22, 1.33, 1.49 , 1.53, 1.77, 1.95 , 2.05 2.53, 2.88	205 (275)	230 (308)	246 (330)	3500
MGX-5075 A	1.06, 1.22, 1.33, 1.53, 1.77, 2.05 2.53, 2.88	205 (275)	230 (308)	246 (330)	3500
MG-5082 SC	1.06, 1.11, 1.16, 1.22 , 1.33, 1.46 , 1.53, 1.77, 2.05, 2.28, 2.53 2.88	301 (404) 273 (366)	336 (451) 313 (420)	350 (469) 331 (444)	3200
MG-5082 A	1.06, 1.33, 1.53, 1.77, 2.05, 2.28, 2.53 2.88	301 (404) 273 (366)	336 (451) 313 (420)	350 (469) 331 (444)	3200
MGX-5086 SC	1.06, 1.11, 1.33, 1.53, 1.77, 2.05, 2.28, 2.53 2.88	301 (404) 273 (366)	336 (451) 313 (420)	350 (469) 331 (444)	3200
MGX-5086 A	1.06, 1.33, 1.53, 1.77, 2.05, 2.28, 2.53 2.88	301 (404) 273 (366)	336 (451) 313 (420)	350 (469) 331 (444)	3200
MG-5091 SC	1.17, 1.45, 1.71, 2.04 2.45, 2.95 3.33	274 (368) 265 (355) 219 (293)	317 (425) 308 (413) 254 (340)	347 (465) 330 (443) 274 (368)	3000
MG-5091 DC	3.82, 4.50 5.05	262 (351) 210 (281)	303 (406) 245 (328)	330 (443) 268 (359)	3000
MGX-5096 A	1.28, 1.52, 1.81, 2.04, 2.48	319 (428)	358 (480)	385 (516)	3000
MGX-5114 SC	0.93, 1.02, 1.10 , 1.12, 1.24, 1.50, 1.74, 2.04, 2.54 3.00	394 (528) 361 (484)	451 (605) 410 (550)	489 (656) 443 (595)	2800 at .93:1 3000 for others
MGX-5114 SC-HD	1.50, 1.74, 2.04, 2.54 3.00	394 (528) 361 (484)	451 (605) 410 (550)	489 (656) 443 (595)	3000
MGX-5114 DC	3.28, 3.43, 4.17, 4.59, 4.86	361 (484)	419 (562)	437 (586)	3000
MGX-5114 RV	1.03, 1.20, 1.48, 1.75, 1.92, 2.04 2.50	357 (479) 338 (453)	407 (546) 385 (516)	440 (590) 417 (559)	3000
MGX-5126A	1.03, 1.20, 1.48, 1.75, 1.92, 2.04 2.50	357 (479) 338 (453)	407 (546) 385 (516)	440 (590) 417 (559)	3000

Important:
See rating definitions, application information, and torsional compatibility notices on pages 38 and 39.
Ratings shown are in SAE Horsepower (HP). Metric Horsepower equals SAE times 1.014.

Bold ratios are available by special order. Contact Twin Disc to confirm availability and lead time.

MODEL	RATIOS	KILOWATTS (HORSEPOWER)			MAXIMUM SPEED (RPM)
		@ 1600 RPM	@ 1800 RPM	@ 2100 RPM	
MGX-5136 SC MG-5136 SC	1.00, 1.10, 1.13, 1.24 , 1.28, 1.48, 1.73, 2.04, 2.57 2.90	447 (599) 413 (554)	485 (650) 448 (601)	542 (727) 500 (671)	2800
MGX-5136 A MG-5136 A	1.16, 1.25, 1.53, 1.79, 2.00, 2.52	447 (599)	485 (650)	542 (727)	2800
MGX-5136 RV MG-5136 RV	1.16, 1.25, 1.53, 1.79, 2.00, 2.52	447 (599)	485 (650)	542 (727)	2800
MGX-5146 SC MG-5146 SC	1.03, 1.08, 1.11 1.20, 1.33, 1.48, 1.57, 1.65 , 1.75, 1.85 , 1.96 2.50	577 (774) 623 (835) 500 (671)	640 (858) 671 (900) 552 (740)	714 (957) 714 (957) 631 (846)	2500
MGX-5146 A MG-5146 A	1.26, 1.48, 1.75, 1.96 2.50	623 (835) 500 (671)	671 (900) 552 (740)	714 (957) 631 (846)	2500
MGX-5146 RV MG-5146 RV	1.26, 1.48, 1.75, 1.96 2.50	623 (835) 500 (671)	671 (900) 552 (740)	714 (957) 631 (846)	2500
MGX-516 MG-516	3.06, 3.50, 4.04, 4.52, 5.05 6.00	397 (532) 365 (489)	447 (600) 406 (544)	465 (624) 425 (570)	2500
MGX-5170 DC MG-5170 DC	3.12, 3.54, 4.06, 4.50, 5.03, 5.95 6.53, 6.95	475 (637) 415 (557)	537 (720) 459 (615)	578 (775) 499 (669)	2500
MGX-5202 SC MG-5202 SC	1.17, 1.33, 1.53, 1.76, 2.03 2.48, 2.92, 3.48	540 (724)	600 (805)	678 (909)	2500
MGX-5204 SC MG-5204 SC	1.17, 1.33, 1.53, 1.76, 2.03, 2.48, 2.92 3.48	633 (849) 540 (724)	716 (960) 600 (805)	797 (1069) 678 (909)	2750 (2500 at 1.17:1)
MGX-5222 DC MG-5222 DC	4.03, 4.59, 5.04, 5.57, 6.10, 6.55, 6.96	540 (724)	600 (805)	678 (909)	2500
MGX-5225 DC MG-5225 DC	4.03, 4.59, 5.04, 5.57, 6.10	644 (864)	727 (975)	787 (1055)	2500
MGX-5321 DC MG-5321 DC	3.35, 4.06, 4.42, 4.96, 5.46 5.96 6.39	928 (1244) 865 (1160) 776 (1041)	1044 (1400) 970 (1300) 863 (1157)	1069 (1434) 1035 (1388) 967 (1297)	2400
		@ 1200 RPM	@ 1600 RPM	@ 1800 RPM	
MG-540 (with flexible coupling)	1.93, 2.58, 2.90	787 (1055)	1049 (1407)	1180 (1582)	1900
	3.26	869 (1165)	1034 (1387)	1163 (1560)	2100
	3.91	648 (869)	864 (1159)	972 (1303)	2400
	4.10, 4.60	787 (1055)	1049 (1407)	1180 (1582)	1900
	5.17	774 (1038)	1032 (1384)	1161 (1557)	2100
	6.18	644 (864)	859 (1152)	966 (1295)	2400
	7.00	571 (766)	762 (1022)	857 (1149)	2400
	7.47	535 (717)	715 (959)	804 (1078)	2400
MG-5506	4.03, 4.55, 4.96, 5.44 6.00	960 (1287) 869 (1165)	1281 (1718) 1159 (1554)	1441 (1932) 1304 (1749)	2000
MGX-5600 MG-5600	2.53, 2.98, 3.51, 4.03, 4.63, 5.04 5.76 6.04	1230 (1649) 1200 (1609) 1016 (1362)	1598 (2143) 1566 (2100) 1309 (1755)	1760 (2360) 1737 (2329) 1451 (1946)	2100

Important:
See rating definitions, application information, and torsional compatibility notices on pages 38 and 39.
Ratings shown are in SAE Horsepower (HP). Metric Horsepower equals SAE times 1.014.

Bold ratios are available by special order. Contact Twin Disc to confirm availability and lead time.

MODEL	RATIOS	KILOWATTS (HORSEPOWER)			MAXIMUM SPEED (RPM)
		@ 1600 RPM	@ 1800 RPM	@ 2100 RPM	
MG-6449 A	1.51, 1.73 2.07 2.44 2.95	680 (912) 565 (758) 494 (662) 435 (583)	741 (994) 617 (827) 537 (720) 489 (656)	833 (1117) 695 (932) 602 (807) 570 (764)	2500
MG-6449 RV	1.51, 1.73 2.07 2.44 2.95	680 (912) 565 (758) 494 (662) 435 (583)	741 (994) 617 (827) 537 (720) 489 (656)	833 (1117) 695 (932) 602 (807) 570 (764)	2500
MGX-6598 DC	2.46, 3.03 3.48 3.93 4.43	759 (1018) 717 (961) 653 (876) 609 (817)	824 (1105) 779 (1045) 710 (952) 662 (888)	918 (1231) 868 (1164) 790 (1059) 737 (988)	2500
MGX-6599 SC	1.07, 1.13, 1.20, 1.26 , 1.30, 1.32, 1.39 , 1.50, 1.58 , 1.66, 1.74, 1.87 , 1.97, 2.04 2.19, 2.45 2.82	713 (956) 713 (956) 615 (825)	774 (1038) 774 (1038) 668 (896)	862 (1156) 862 (1156) 744 (998)	2500
MGX-6599 A	1.34, 1.51, 1.74, 2.03, 2.24 2.48 2.80	754 (1011) 711 (953) 654 (877)	820 (1100) 772 (1035) 709 (951)	910 (1220) 860 (1153) 790 (1059)	2500
MGX-6599 RV	1.34, 1.51, 1.74, 2.03, 2.24 2.48 2.80	754 (1011) 711 (953) 654 (877)	820 (1100) 772 (1035) 709 (951)	910 (1220) 860 (1153) 790 (1059)	2500
MG-6600 DC	3.30, 4.11 4.68, 4.72 5.22 6.05	663 (889) 639 (857) 559 (750) 496 (665)	746 (1000) 719 (964) 629 (843) 558 (748)	850 (1140) 819 (1098) 716 (960) 636 (853)	2500
MGX-6620 SC	1.15, 1.18, 1.24 , 1.33, 1.42, 1.50 , 1.53, 1.56 , 1.60, 1.65, 1.71 , 1.73 1.81 , 2.03, 2.14, 2.25 , 2.32 2.44 2.54, 2.72	884 (1185) 861 (1155) 834 (1118) 773 (1037)	960 (1287) 935 (1254) 906 (1215) 839 (1125)	998 (1338) 998 (1338) 998 (1338) 935 (1254)	2500
MGX-6620 A	1.55, 1.72, 2.09 2.28, 2.42 2.73	926 (1242) 868 (1164) 769 (1031)	1021 (1369) 943 (1265) 835 (1120)	1132 (1518) 1050 (1408) 930 (1247)	2500
MGX-6620 RV	1.55 1.72 2.09 2.28, 2.42 2.73	871 (1168) 843 (1130) 800 (1073) 777 (1042) 707 (948)	946 (1269) 915 (1227) 869 (1165) 844 (1132) 767 (1029)	1054 (1413) 1020 (1368) 968 (1298) 940 (1261) 855 (1147)	2500
MGX-6690 SC MG-6690 SC	1.51, 1.88, 2.03, 2.37, 2.47 2.81, 2.93 3.21	1054 (1413) 1034 (1387) 1018 (1365)	1174 (1574) 1144 (1534) 1119 (1501)	1277 (1712) 1209 (1621) 1194 (1601)	2300 (1.51-2.03) 2500 (2.37-3.21)
MGX-6848 SC MG-6848 SC	1.51, 1.88, 2.03, 2.37, 2.47, 2.58, 2.81, 2.93 3.21	1187 (1592) 1103 (1479)	1342 (1800) 1226 (1644)	1566 (2100) 1404 (1883)	2300 (1.51-2.03) 2500 (2.37-3.21)

Important:
See rating definitions, application information, and torsional compatibility notices on pages 38 and 39.
Ratings shown are in SAE Horsepower (HP). Metric Horsepower equals SAE times 1.014.

Bold ratios are available by special order. Contact Twin Disc to confirm availability and lead time.

MEDIUM DUTY RATINGS

STANDARD & QUICKSHIFT
MARINE TRANSMISSIONS



MODEL	RATIOS	KILOWATTS (HORSEPOWER)			MAXIMUM SPEED (RPM)
		@ 1200 RPM	@ 1600 RPM	@ 1800 RPM	
MG-6984 SC	1.18, 1.54, 2.06, 2.29, 2.52, 2.92 3.25 3.43	902 (1210) 818 (1097) 616 (826)	1203 (1613) 1090 (1462) 821 (1101)	1353 (1814) 1227 (1645) 924 (1239)	2100
MG-6984 A	1.48, 1.97, 2.50, 2.79 2.93	923 (1238) 887 (1189)	1230 (1649) 1182 (1585)	1384 (1856) 1330 (1784)	2100
MG-6984 RV	1.48, 1.97, 2.50, 2.79 2.93	923 (1238) 887 (1189)	1230 (1649) 1182 (1585)	1384 (1856) 1330 (1784)	2100
MGX-61000 SC	1.79, 1.84, 1.96, 2.22, 2.54, 2.63, 2.72, 3.03, 3.39	1119 (1500)	1491 (2000)	1678 (2250)	2100
MG-61242 SC	1.16, 1.52, 2.08, 2.47 2.96	1315 (1763) 1268 (1700)	1754 (2352) 1691 (2268)	1973 (2646) 1902 (2551)	2100
MG-61242 A	1.42, 2.07, 2.44 2.93	1315 (1763) 1263 (1694)	1754 (2352) 1685 (2260)	1973 (2646) 1896 (2543)	2100
MG-61242 RV	1.42, 2.07, 2.44 2.93	1315 (1763) 1263 (1694)	1754 (2352) 1685 (2260)	1973 (2646) 1896 (2543)	2100
MGX-61500 SC	1.84, 1.98, 2.45, 2.56, 2.86, 2.97 3.03, 3.41	1560 (2092) 1333 (1788)	2080 (2789) 1778 (2384)	2340 (3138) 2000 (2682)	2100
		@ 1600 RPM	@ 1800 RPM	@ 2100 RPM	
MGX-61500 SC-HL/HR	1.84, 1.98, 2.18, 2.26, 2.56, 2.97	2079 (2788)	2339 (3137)	2729 (3660)	2100

MEDIUM DUTY RATINGS

MARINE GEARS FOR ELECTRIC & HYBRID PROPULSION

MODEL	RATIOS	KILOWATTS (HORSEPOWER)			MAXIMUM SPEED (RPM)
		@ 1800 RPM	@ 2100 RPM	@ 2300 RPM	
MGE-5065SC	1.47, 1.72 , 2.04 2.43	227 (304) 208 (279)	262 (351) 243 (326)	285 (382) 266 (357)	3600
MGH-5075SC	1.06, 1.22, 1.33, 1.53, 1.77, 2.05 2.53 2.88	205 (275)	230 (308)	246 (330)	3500
MGE-5126SC	1.50, 1.74 , 2.04, 2.54 3.00	394 (528) 361 (484)	451 (605) 410 (550)	489 (656) 443 (595)	3000
		@ 1600 RPM	@ 1800 RPM	@ 2100 RPM	
MGE-5204SC	1.53, 1.76 , 2.03, 2.48, 2.92 3.48	633 (849) 540 (724)	716 (960) 600 (805)	797 (1069) 678 (909)	2300

Important:

See rating definitions, application information, and torsional compatibility notices on pages 38 and 39. Ratings shown are in SAE Horsepower (HP). Metric Horsepower equals SAE times 1.014.

Bold ratios are available by special order. Contact Twin Disc to confirm availability and lead time.

CONTINUOUS DUTY RATINGS

STANDARD & QUICKSHIFT
MARINE TRANSMISSIONS



MODEL	RATIOS	KILOWATTS (HORSEPOWER)			MAXIMUM SPEED (RPM)
		@ 1800 RPM	@ 2100 RPM	@ 2300 RPM	
MG-340	F: 1.45 / R: 2.13 F: 2.00 / R: 2.13 F: 2.60 / R: 2.13	F: 18(24) / R: 6(8) F: 13(17) / R: 4(6) F: 9(12) / R: 3(4)	F: 21(28) / R: 7(9) F: 15(20) / R: 5(7) F: 11(15) / R: 4(5)	F: 23(31) / R: 8(10) F: 16(21) / R: 5(7) F: 12(16) / R: 4(5)	4500
MG-360	F: 1.55 / R: 2.00 F: 2.00 / R: 2.00 F: 2.45 / R: 2.45 F: 2.83 / R: 2.45	F: 23(31) / R: 17(23) F: 21(28) / R: 17(23) F: 17(23) / R: 14(19) F: 14(19) / R: 14(19)	F: 26(35) / R: 19(26) F: 24(32) / R: 19(26) F: 20(27) / R: 16(22) F: 16(22) / R: 16(22)	F: 29(39) / R: 21(28) F: 26(35) / R: 21(28) F: 21(28) / R: 17(23) F: 17(23) / R: 17(23)	5000
MG-5005 A	1.54, 2.00 2.47	35(47) 26(35)	41(55) 30(40)	45(60) 33(44)	4500
MG-5012 SC	1.51 2.09 2.40 2.77	74(99) 64(86) 58(77) 50(67)	86(115) 75(100) 67(90) 58(78)	94(126) 82(110) 74(99) 64(86)	4500
MG-5020 SC	1.50, 2.04 2.50 2.94	104(139) 83(111) 72(96)	121(162) 97(130) 84(112)	133(178) 106(142) 92(123)	4000
MG-5025 A	1.52, 2.09 2.40	59(79) 52(70)	69(93) 61(82)	75(101) 67(90)	4500
MG-5055 A	1.53, 2.08 2.60	105(141) 60(82)	123(165) 70(95)	135(181) 77(103)	4000
MG-5050 SC	1.00, 1.11, 1.23, 1.53, 1.71, 2.04, 2.45 3.00	104(139) 93(125)	116(156) 108(145)	127(170) 121(162)	3300
MG-5050 A	1.12, 1.26, 1.50, 1.80, 2.04, 2.50	104(139)	116(156)	127(170)	3300
MG-5050 RV	1.12, 1.26, 1.50, 1.80, 2.04, 2.50	104(139)	116(156)	127(170)	3300
MG-5061 SC	1.15, 1.22 , 1.29 , 1.48, 1.77, 2.00, 2.43 3.00	123(165) 115(154)	142(190) 133(178)	155(208) 145(194)	3300
MG-5061 A	1.13, 1.28, 1.54, 1.75, 2.00 2.47	123(165) 115(154)	142(190) 133(178)	155(208) 145(194)	3300
MGX-5065 SC MG-5065 SC	1.08, 1.26, 1.39 , 1.47, 1.72, 2.04 2.43	216(290) 199(267)	250(335) 232(311)	272(365) 254(341)	3600
MGX-5065 A MG-5065 A	1.08, 1.26, 1.47, 1.72, 2.04 2.43	216(290) 199(267)	250(335) 232(311)	272(365) 254(341)	3600
MGX-5075 SC MG-5075 SC	1.06, 1.22, 1.33, 1.49 , 1.53, 1.77, 1.95 , 2.05, 2.53, 2.88	186(249)	209(280)	224(300)	3500
MGX-5075 A MG-5075 A	1.06, 1.22, 1.33, 1.53, 1.77, 2.05, 2.53, 2.88	186(249)	209(280)	224(300)	3500
MG-5082 SC	1.06, 1.11, 1.16 , 1.22 , 1.33, 1.46 , 1.53, 1.77, 2.05, 2.28, 2.53, 2.88	262(351)	292(392)	310(416)	3200
MG-5082 A	1.06, 1.33, 1.53, 1.77, 2.05, 2.28, 2.53, 2.88	262(351)	292(392)	310(416)	3200
MGX-5086 SC	1.06, 1.11, 1.33, 1.53, 1.77, 2.05, 2.28, 2.53, 2.88	262(351)	292(392)	310(416)	3200
MGX-5086 A	1.06, 1.33, 1.53, 1.77, 2.05, 2.28, 2.53, 2.88	262(351)	292(392)	310(416)	3200

Important:

See rating definitions, application information, and torsional compatibility notices on pages 38 and 39. Ratings shown are in SAE Horsepower (HP). Metric Horsepower equals SAE times 1.014.

**F = Forward Ratios and Ratings; R = Reverse Ratings and Ratios

Bold ratios are available by special order. Contact Twin Disc to confirm availability and lead time.

MODEL	RATIOS	KILOWATTS (HORSEPOWER)			MAXIMUM SPEED (RPM)
		@ 1800 RPM	@ 2100 RPM	@ 2300 RPM	
MG-5091 SC	1.17, 1.45, 1.71, 2.04, 2.45, 2.95 3.33	242 (325) 205 (275)	280 (375) 239 (320)	306 (410) 261 (350)	3000
MG-5091 DC	3.82, 4.50 5.05	242 (325) 205 (275)	280 (375) 239 (320)	306 (410) 261 (350)	3000
MGX-5096A MG-5096A	1.28, 1.52, 1.81, 2.04, 2.48	298 (400)	335 (449)	360 (483)	3000
MGX-5114 SC MG-5114 SC	0.93, 1.02, 1.10 , 1.12, 1.24, 1.50, 1.74, 2.04, 2.54 3.00	358 (480) 328 (440)	410 (550) 373 (500)	444 (595) 403 (540)	2800 at .93:1 3000 for others
MGX-5114 SC-HD MG-5114 SC-HD	1.50, 1.74, 2.04, 2.54 3.00	358 (480) 328 (440)	410 (550) 373 (500)	444 (595) 403 (540)	3000
MGX-5114 DC MG-5114 DC	3.28, 3.43, 4.17, 4.59, 4.86	347 (465)	403 (540)	421 (565)	3000
MGX-5114 RV MG-5114 RV	1.03, 1.20, 1.48, 1.75, 1.92, 2.04 2.50	347 (465) 321 (430)	387 (519) 366 (491)	418 (561) 396 (531)	3000
MGX-5126A MG-5126A	1.03, 1.20, 1.48, 1.75, 1.92, 2.04 2.50	347 (465) 321 (430)	387 (519) 366 (491)	418 (561) 396 (531)	3000
		@ 1600 RPM	@ 1800 RPM	@ 2100 RPM	
MGX-5136 SC MG-5136 SC	1.00, 1.10, 1.13 , 1.24 , 1.28, 1.48, 1.73, 2.04, 2.57 2.90	410 (550) 376 (504)	445 (597) 408 (547)	497 (666) 456 (611)	2800
MGX-5136 A MG-5136 A	1.16, 1.25, 1.53, 1.79, 2.00, 2.52	410 (550)	445 (597)	497 (666)	2800
MGX-5136 RV MG-5136 RV	1.16, 1.25, 1.53, 1.79, 2.00, 2.52	410 (550)	445 (597)	497 (666)	2800
MGX-5146 SC MG-5146 SC	1.03, 1.08 , 1.11 1.20, 1.33, 1.48, 1.57, 1.65 , 1.75, 1.85 , 1.96 2.50	557 (747) 565 (758) 481 (645)	612 (821) 612 (821) 537 (720)	660 (885) 660 (885) 615 (825)	2500
MGX-5146 A MG-5146 A	1.26, 1.48, 1.75, 1.96 2.50	565 (758) 481 (645)	612 (821) 537 (720)	660 (885) 615 (825)	2500
MGX-5146 RV MG-5146 RV	1.26, 1.48, 1.75, 1.96 2.50	565 (758) 481 (645)	612 (821) 537 (720)	660 (885) 615 (825)	2500
MGX-516 MG-516	3.06, 3.50, 4.04, 4.52, 5.05 6.00	397 (532) 365 (489)	447 (600) 406 (544)	465 (624) 425 (570)	2500
MGX-5170 DC MG-5170 DC	3.12, 3.54, 4.06, 4.50, 5.03, 5.95 6.53, 6.95	448 (601) 408 (547)	507 (680) 459 (615)	541 (725) 478 (641)	2500
MGX-5202 SC MG-5202 SC	1.17, 1.33, 1.53, 1.76, 2.03, 2.48, 2.92 3.48	540 (724)	600 (805)	678 (909)	2500
MGX-5204 SC MG-5204 SC	1.17, 1.33, 1.53, 1.76, 2.03, 2.48, 2.92 3.48	633 (849) 540 (724)	716 (960) 600 (805)	797 (1069) 678 (909)	2750 (2500 at 1.17:1)
MGX-5222 DC MG-5222 DC	4.03, 4.59, 5.04, 5.57, 6.10, 6.55, 6.96	540 (724)	600 (805)	678 (909)	2500
MGX-5225 DC MG-5225 DC	4.03, 4.59, 5.04, 5.57, 6.10	633 (849)	716 (960)	735 (986)	2500
MGX-5321 DC MG-5321 DC	3.35, 4.06, 4.42, 4.96, 5.46 5.96 6.39	882 (1183) 861 (1155) 737 (988)	982 (1317) 970 (1300) 812 (1089)	1000 (1341) 970 (1300) 905 (1214)	2400

Important:

See rating definitions, application information, and torsional compatibility notices on pages 38 and 39. Ratings shown are in SAE Horsepower (HP). Metric Horsepower equals SAE times 1.014.

Bold ratios are available by special order. Contact Twin Disc to confirm availability and lead time.

MODEL	RATIOS	KILOWATTS (HORSEPOWER)			MAXIMUM SPEED (RPM)
		@ 1200 RPM	@ 1600 RPM	@ 1800 RPM	
MG-540 (with flexible coupling)	1.93, 2.58, 2.90	787 (1055)	1049 (1407)	1180 (1582)	1900
	3.26	776 (1041)	1034 (1387)	1163 (1560)	2100
	3.91	648 (869)	864 (1159)	972 (1303)	2400
	4.60	787 (1055)	1049 (1407)	1180 (1582)	1900
	5.17	774 (1038)	1032 (1384)	1161 (1557)	2100
	6.18	644 (864)	859 (1152)	969 (1300)	2400
	7.00	571 (766)	762 (1022)	895 (1200)	2400
	7.47	535 (717)	715 (959)	804 (1078)	2400
MG-5506	4.03, 4.55, 4.96, 5.44 6.00	937 (1257) 848 (1137)	1249 (1675) 1130 (1515)	1406 (1885) 1279 (1715)	2000
MGX-5600 MG-5600	2.53, 2.98, 3.51, 4.03, 4.63, 5.04 5.76 6.04	1230 (1649) 1200 (1609) 985 (1321)	1575 (2112) 1566 (2100) 1271 (1704)	1760 (2360) 1737 (2329) 1410 (1891)	2100
MGX-5600DR MG-5600DR	4.20, 6.02 6.56 7.01 7.22	1151 (1543) 1038 (1392) 964 (1293) 845 (1133)	1564 (2097) 1458 (1955) 1352 (1813) 1088 (1459)	1760 (2360) 1641 (2201) 1566 (2100) 1207 (1619)	2100
MGN-1814 V	2.53, 3.00, 3.29, 3.62, 4.00 4.22	1600 (2146) 1548 (2076)	2133 (2860) 2064 (2768)	2350 (3151) 2240 (3004)	2000
MGN-1816 V	4.43, 4.85, 5.12, 5.33, 5.61 5.91	1600 (2146) 1500 (2012)	2133 (2860) 2000 (2682)	2350 (3151) 2240 (3004)	2000
MGN-1817 V	6.00, 6.56, 6.88, 7.22 7.59	1600 (2146) 1548 (2076)	2133 (2860) 2064 (2768)	2350 (3151) 2240 (3004)	2000
MGN-1819 V	8.04, 8.42, 8.83 9.27	1600 (2146) 1548 (2076)	2133 (2860) 2064 (2768)	2350 (3151) 2240 (3004)	2000
		@ 1600 RPM	@ 1800 RPM	@ 2100 RPM	
MG-6449 A	1.51, 1.73 2.07 2.44 2.95	640 (858) 529 (709) 462 (620) 413 (554)	695 (932) 574 (770) 502 (673) 448 (601)	778 (1043) 642 (861) 562 (754) 501 (672)	2500
MG-6449 RV	1.51, 1.73 2.07 2.44 2.95	640 (858) 529 (709) 462 (620) 413 (554)	695 (932) 574 (770) 502 (673) 448 (601)	778 (1043) 642 (861) 562 (754) 501 (672)	2500
MGX-6598 DC	2.46, 3.03 3.48 3.93 4.43	710 (952) 670 (898) 611 (819) 570 (764)	771 (1034) 729 (978) 664 (890) 619 (830)	858 (1151) 811 (1088) 739 (991) 690 (925)	2500
MGX-6599 SC	1.07, 1.13 , 1.20 , 1.26 , 1.30, 1.32 , 1.39 , 1.50, 1.58 , 1.66, 1.74 1.87 , 1.97, 2.04, 2.19, 2.45 2.82	685 (919) 670 (898) 575 (771)	744 (998) 728 (976) 624 (837)	828 (1110) 806 (1081) 696 (933)	2500
MGX-6599 A	1.34, 1.51, 1.74, 2.03, 2.24 2.48 2.80	706 (947) 668 (896) 644 (864)	767 (1029) 728 (976) 699 (937)	851 (1141) 804 (1078) 779 (1045)	2500
MGX-6599 RV	1.34, 1.51, 1.74, 2.03, 2.24 2.48 2.80	706 (947) 668 (896) 644 (864)	767 (1029) 728 (976) 699 (937)	851 (1141) 804 (1078) 779 (1045)	2500
MG-6600 DC	3.30, 4.11 4.68, 4.72 5.22 6.05	637 (854) 623 (835) 534 (716) 473 (634)	716 (960) 701 (940) 600 (805) 532 (713)	835 (1120) 818 (1097) 699 (937) 621 (833)	2500

Important:
See rating definitions, application information, and torsional compatibility notices on pages 38 and 39.
Ratings shown are in SAE Horsepower (HP). Metric Horsepower equals SAE times 1.014.

Bold ratios are available by special order. Contact Twin Disc to confirm availability and lead time.

CONTINUOUS DUTY RATINGS

STANDARD & QUICKSHIFT
MARINE TRANSMISSIONS



MODEL	RATIOS	KILOWATTS (HORSEPOWER)			MAXIMUM SPEED (RPM)
		@ 1600 RPM	@ 1800 RPM	@ 2100 RPM	
MGX-6620 SC	1.15, 1.18, 1.24 , 1.33, 1.42, 1.50 , 1.53, 1.56, 1.60, 1.65, 1.71 , 1.73 1.81 , 2.03 2.14, 2.25, 2.32 2.44 2.54, 2.72	827 (1109) 810 (1086) 805 (1080) 780 (1046) 723 (970)	898 (1204) 879 (1179) 874 (1172) 847 (1136) 785 (1053)	934 (1252) 934 (1252) 934 (1252) 934 (1252) 875 (1173)	2500
MGX-6620 A	1.55, 1.72, 2.09 2.28, 2.42 2.73	875 (1173) 767 (1029) 719 (964)	950 (1274) 833 (1117) 780 (1046)	1059 (1420) 928 (1244) 869 (1165)	2500
MGX-6620 RV	1.55 1.72 2.09 2.28, 2.42 2.73	815 (1093) 788 (1057) 749 (1004) 727 (975) 661 (886)	885 (1187) 856 (1148) 813 (1090) 789 (1058) 718 (963)	986 (1322) 954 (1279) 905 (1214) 879 (1179) 799 (1071)	2500
MGX-6690 SC MG-6690 SC	1.51, 1.88, 2.03, 2.37, 2.47 2.81, 2.93 3.21	1017 (1364) 977 (1310) 943 (1265)	1129 (1514) 1069 (1434) 1028 (1379)	1195 (1602) 1130 (1515) 1098 (1472)	2300 (1.51-2.03) 2500 (2.37-3.21)
MGX-6848 SC MG-6848 SC	1.51, 1.88, 2.03, 2.37, 2.47, 2.58, 2.81, 2.93 3.21	1111 (1490) 1074 (1440)	1250 (1676) 1194 (1601)	1420 (1904) 1350 (1810)	2300 (1.51-2.03) 2500 (2.37-3.21)
		@ 1200 RPM	@ 1600 RPM	@ 1800 RPM	
MG-6984 SC	1.18, 1.54, 2.06, 2.29, 2.52, 2.92 3.25 3.43	884 (1185) 800 (1073) 602 (807)	1178 (1580) 1066 (1430) 802 (1075)	1326 (1778) 1200 (1609) 903 (1211)	2100
MG-6984 A	1.48, 1.97, 2.50, 2.79 2.93	905 (1214) 867 (1163)	1206 (1617) 1157 (1552)	1356 (1818) 1301 (1745)	2100
MG-6984 RV	1.48, 1.97, 2.50, 2.79 2.93	905 (1214) 867 (1163)	1206 (1617) 1157 (1552)	1356 (1818) 1301 (1745)	2100
MGX-61000 SC	1.79, 1.84, 1.96, 2.22, 2.54, 2.63, 2.72, 3.03, 3.39	Please contact Twin Disc			2100
MG-61242 SC	1.16, 1.52 2.08, 2.47, 2.96	1250 (1676) 1173 (1573)	1667 (2235) 1512 (2028)	1875 (2514) 1760 (2360)	2100
MG-61242 A	1.49, 2.08 2.44 2.93	1239 (1661) 1189 (1594) 1173 (1573)	1651 (2214) 1585 (2125) 1565 (2099)	1858 (2492) 1782 (2390) 1760 (2360)	2100
MG-61242 RV	1.49, 2.08 2.44 2.93	1239 (1661) 1189 (1594) 1173 (1573)	1651 (2214) 1585 (2125) 1565 (2099)	1858 (2492) 1782 (2390) 1760 (2360)	2100
MGX-61500 SC	1.84, 1.98, 2.26, 2.39, 2.45 2.56, 2.86, 2.97, 3.03, 3.41	Please contact Twin Disc			2100
MGX-61500SC-HL/HR	1.84, 1.98, 2.18, 2.26, 2.56, 2.97	Please contact Twin Disc			2100

CONTINUOUS DUTY RATINGS

MARINE GEARS FOR ELECTRIC & HYBRID PROPULSION

MODEL	RATIOS	KILOWATTS (HORSEPOWER)			MAXIMUM SPEED (RPM)
		@ 1800 RPM	@ 2100 RPM	@ 2300 RPM	
MGE-5065SC	1.47, 1.72 , 2.04 2.43	216 (290) 199 (267)	250 (335) 232 (311)	272 (365) 254 (341)	3600
MGH-5075SC	1.06, 1.22, 1.33, 1.53, 1.77, 2.05 2.53 2.88	186 (249)	209 (280)	224 (300)	3500
MGE-5126SC	1.50, 1.74 , 2.04, 2.54 3.00	358 (480) 328 (440)	410 (550) 373 (500)	444 (595) 403 (540)	3000
		@ 1600 RPM	@ 1800 RPM	@ 2100 RPM	
MGE-5204SC	1.53, 1.76 , 2.03, 2.48, 2.92 3.48	633 (849) 540 (724)	716 (960) 600 (805)	797 (1069) 678 (909)	2300

Important:
See rating definitions, application information, and torsional compatibility notices on pages 38 and 39.
Ratings shown are in SAE Horsepower (HP). Metric Horsepower equals SAE times 1.014.

Bold ratios are available by special order. Contact Twin Disc to confirm availability and lead time.

DIMENSIONS AND WEIGHTS FOR TWIN DISC MARINE TRANSMISSIONS

(A) Vertical Offset

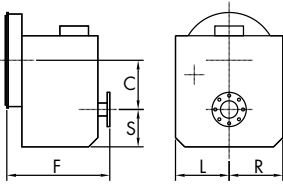

(B) Vertical Offset Downangle

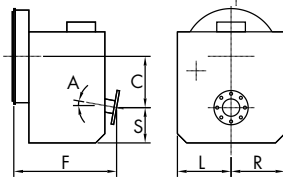

(C) Remote V-Drive

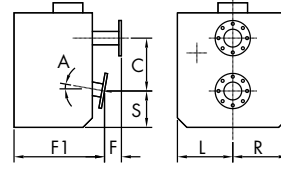

(D) Integral V-Drive

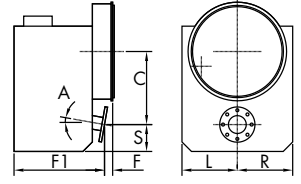

Model	Assembly Drawing	Installation Drawing Series	Con-fig.	SAE Housing	A	C (offset) in (mm)
MG-340	IT101317501	IT40TD0004	A	5, BW	—	2.66(68)
MG-360	IT101319505	IT60TD0004	A	5, BW	—	3.10(79)
MG-5005 A	IT345ATD0001	IT1023041	B	3, 4, 5	8°	4.37(111)
MG-5012 SC	IT1013079B01	IT93TD0001	A	3, 4, BW	—	4.35(110)
MG-5020 SC	IT1013049B01	IT170TD0001	A	3, 4, BW	—	5.18(132)
MG-5025 A	IT1013170	IT485ATD0000	B	3, 4, BW	8°	4.96(126)
MG-5055 A	IT101316101	IT880ATD0002	B	3, 4, BW	10°	6.10(155)
MG-5050 SC	PX-12700	PX-13021	A	1, 2, 3, 4	—	5.28(134)
MG-5050 A	PX-12730	PX-13019	B	1, 2, 3, 4	10°	5.52(140)
MG-5050 RV	PX-8760	PX-8760	C	—	10°	5.52(140)
MG-5061 SC	PX-11650/-A	1026328	A	1, 2, 3	—	5.66(144)
MG-5061 A	PX-11640/-A	1026225	B	1, 2, 3	7°	5.75(146)
MGX-5065 SC	PX-12410-A	1026371	A	1, 2, 3	—	6.00(152)
MGX-5065 A	PX-12370-A	1026215	B	1, 2, 3	7°	6.69(170)
MG-5065 SC	PX-11480-A	1026372-A	A	1, 2, 3	—	6.00(152)
MG-5065 A	PX-11165-B	1026552	B	1, 2, 3	7°	6.69(170)
MGX-5075 SC	PX-12620	PX-13174	A	1, 2, 3	—	0.59(15)
MGX-5075 A	PX-12610	PX-12610	B	1, 2, 3	7°	1.91(48)
MG-5075 SC	PX-11876 & PX-11876	1026311	A	1, 2, 3	—	0.59(15)
MG-5075 SC	PX-10680/-A	PX-10680/-A	A	1, 2, 3	—	0.59(15)
MG-5075 A	PX-10700/-A	1026876	B	1, 2, 3	7°	1.91(48)
MG-5082 SC	PX-11250-A	PX-11250-A	A	1, 2, 3	—	0.59(15)
MG-5082 A	PX-11040-B	PX-11040-B	B	1, 2, 3	7°	2.12(54)
MGX-5086 SC	PX-12600	PX-12600	A	1, 2, 3	—	0.59(15)
MGX-5086 A	PX-12290	PX-13064	B	1, 2, 3	7°	2.12(54)
MG-5091 SC	PX-10016	1026295	A	1, 2	—	6.82(173)
MG-5091 DC	1002155/ PX-12636(FS)	1026877/ PX-12636(FS)	A	1, 2	—	9.49(241)
MGX-5096A	PX12680A	PX12820	B	1, 2	7°	7.51(191)
MG-5096A	PX13225	PX13226	B	1, 2	7°	7.51(191)

S (sump) in (mm)	F (length) in (mm)	F1 (length) in (mm)	L (mounting pad) in (mm)	R (mounting pad) in (mm)	Weight lb (kg)
2.46(63)	7.17(182)	—	—	2.95(75)	20(9)
3.56(83)	9.65(245)	—	—	—	31(14)
3.19(81)	8.82(224)	—	—	—	55(25)
4.92(125)	10.14(258)	—	6.61(168)	6.61(168)	117(53)
5.17(131)	10.53(268)	—	7.60(193)	7.60(193)	165(75)
3.43(87)	10.63(270)	—	6.50(165)	6.50(165)	79(36)
4.25(108)	10.51(267)	—	7.60(193)	7.60(193)	119(54)
4.69(119)	12.78(325)	—	8.13(207)	5.85(149)	189(86)
3.68(93)	12.10(307)	—	8.13(207)	5.85(149)	176(80)
3.68(93)	3.06(78)	10.13(257)	8.13(207)	5.85(149)	160(73)
4.84(123)	13.18(335)	—	8.40(213)	6.15(156)	215(98)
4.21(107)	12.53(318)	—	8.40(213)	6.16(156)	210(95)
5.22(133)	13.30(338)	—	10.00(254)	6.50(165)	244(111)
4.84(123)	12.97(329)	—	10.00(254)	6.50(165)	244(111)
5.22(133)	13.30(338)	—	10.00(254)	6.50(165)	244(111)
4.84(123)	12.97(329)	—	10.00(254)	6.50(165)	244(111)
7.00(178)	14.11(358)	—	10.00(254)	10.00(254)	268(122)
7.00(178)	13.80(350)	—	10.00(254)	10.00(254)	268(122)
7.00(178)	14.11(358)	—	10.00(254)	10.00(254)	268(122)
7.00(178)	14.11(358)	—	10.00(254)	10.00(254)	268(122)
7.00(178)	16.24(413)	—	10.00(254)	10.00(254)	298(135)
7.00(178)	15.97(405)	—	10.00(254)	10.00(254)	298(135)
7.00(178)	16.24(413)	—	10.00(254)	10.00(254)	298(135)
7.00(178)	15.97(405)	—	10.00(254)	10.00(254)	298(135)
6.22(158)	16.59(421)	—	10.25(260)	6.94(176)	485(220)
9.60(244)	18.09(459)	—	11.12(282)	11.12(282)	655(297)
5.45(139)	19.76(502)	—	10.43(265)	10.43(265)	440(200)
5.45(139)	19.76(502)	—	10.43(265)	10.43(265)	416(189)

Use certified drawings for installation.

Dry weights are approximate and vary by input and ratio.

Specifications are subject to change without notice.

Dimensions may vary with housing adapter or output flange.

Important: Weights are approximate and include flywheel housing adapter and flexible input coupling.

DIMENSIONS AND WEIGHTS FOR TWIN DISC MARINE TRANSMISSIONS

(A) Vertical Offset

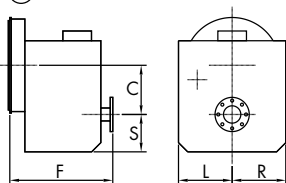

(B) Vertical Offset Downangle

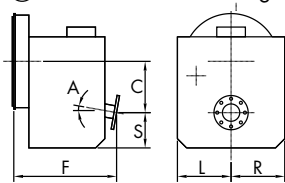

(C) Remote V-Drive

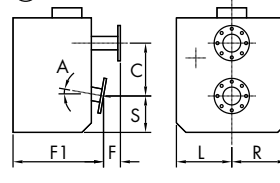

(D) Integral V-Drive

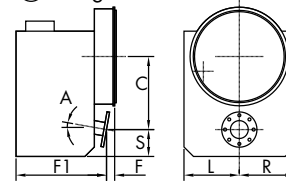

Model	Assembly Drawing	Installation Drawing Series	Con-fig.	SAE Housing	A	C (offset) in (mm)
MGX-5114 SC	PX-13160	PX-13254	A	1	—	7.47 (190)
MGX-5114 SC-HD	PX-13165	PX-13252	A	1	—	7.47 (190)
MGX-5114 DC	PX-13190	PX-13298	A	1	—	10.90 (277)
MGX-5114 RC	PX-13270	PX-13365	C	—	7°	8.00 (203)
MG-5114 SC	PX-13150	PX-13253	A	1	—	7.47 (190)
MG-5114 SC-HD	PX-13155	PX-13251	A	1, Ind.	—	7.47 (190)
MG-5114 DC	PX-13180	PX-13297	A	1, Ind.	—	10.90 (277)
MG-5114 RV	PX-13280	PX-13366	C	—	7°	8.00 (203)
MGX-5126 A	PX12870	1026597	B	1	7°	8.11 (206)
MG-5126 A	PX13235	PX13236	B	1	7°	8.11 (206)
MGX-5136SC	1027445	1027608	A	1, 0	—	7.87 (200)
MGX-5136A	1025600	1027607	B	1, 0	10°	9.12 (232)
MGX-5136RV	1027556	1027609	C	—	10°	9.12 (232)
MG-5136SC	1027560	1027762	A	1, 0	—	7.87 (200)
MG-5136A	1027557	1027761	B	1, 0	10°	9.12 (232)
MG-5136RV	1027561	1027763	C	—	10°	9.12 (232)
MGX-5146SC	1027661	1027662	A	1, 0	—	8.12 (206)
MGX-5146A	1027596	1027597	B	1, 0	10°	10.40 (264)
MGX-5146RV	1027740	1027741	C	—	10°	10.40 (264)
MG-5146SC	1027904	1027905	A	1, 0	—	8.12 (206)
MG-5146A	1027902	1027903	B	1, 0	10°	10.40 (264)
MG-5146RV	1027906	1027907	C	—	10°	10.40 (264)
MGX-516	1023380	1026197	A	1, 0 (14" only)	—	13.29 (338)
MGX-5170 DC	1023382	1026199	A	1, 0	—	15.15 (385)
MGX-5202 SC	1026316	1026322	A	1, 0, Ind.	—	9.75 (248)
MGX-5204 SC	1026193	1026242	A	1, 0, Ind.	—	9.75 (248)
MGX-5222 DC	1022822-A	1025541	A	1, 0, Ind.	—	15.75 (400)
MGX-5225 DC	1022825-A	1025541	A	1, 0, Ind.	—	15.75 (400)
MGX-5321 DC	1022203-B	1026064	A	0, 00, Ind.	—	17.32 (440)

S (sump) in (mm)	F (length) in (mm)	F1 (length) in (mm)	L (mounting pad) in (mm)	R (mounting pad) in (mm)	Weight lb (kg)
6.33 (161)	19.00 (483)	—	11.00 (279)	7.50 (191)	503 (228)
6.33 (161)	19.00 (483)	—	11.00 (279)	11.00 (279)	630 (286)
9.85 (250)	19.03 (483)	—	11.25 (286)	11.25 (286)	868 (394)
5.25 (133)	2.12 (54)	17.69 (449)	11.00 (279)	8.00 (203)	435 (198)
6.33 (161)	19.00 (483)	—	11.00 (279)	7.50 (191)	503 (228)
6.33 (161)	19.00 (483)	—	11.00 (279)	11.00 (279)	619 (281)
9.85 (250)	19.03 (483)	—	11.25 (286)	11.25 (286)	841 (382)
5.25 (133)	2.12 (54)	17.69 (449)	11.00 (279)	8.00 (203)	435 (198)
5.13 (130)	21.53 (547)	—	11.00 (279)	8.00 (203)	531 (241)
5.13 (130)	21.53 (547)	—	11.00 (279)	8.00 (203)	513 (233)
7.48 (190)	22.52 (572)	—	12.01 (305)	12.01 (305)	650 (295)
6.26 (159)	21.93 (557)	—	12.01 (305)	12.01 (305)	661 (300)
6.26 (159)	4.46 (113)	18.02 (458)	12.01 (305)	12.01 (305)	588 (267)
7.48 (190)	22.52 (572)	—	12.01 (305)	12.01 (305)	634 (288)
6.26 (159)	21.93 (557)	—	12.01 (305)	12.01 (305)	645 (293)
6.26 (159)	4.46 (113)	18.02 (458)	12.01 (305)	12.01 (305)	573 (260)
7.04 (179)	22.52 (572)	—	12.01 (305)	12.01 (305)	758 (344)
6.13 (156)	21.85 (555)	—	12.01 (305)	12.01 (305)	780 (354)
6.13 (156)	5.68 (144)	17.96 (456)	12.01 (305)	12.01 (305)	700 (318)
7.04 (179)	22.52 (572)	—	12.01 (305)	12.01 (305)	747 (339)
6.13 (156)	21.85 (555)	—	12.01 (305)	12.01 (305)	771 (350)
6.13 (156)	5.68 (144)	17.96 (456)	12.01 (305)	12.01 (305)	692 (314)
12.77 (324)	20.59 (523)	—	14.00 (356)	14.00 (356)	1658 (752)
14.23 (361)	22.55 (573)	—	15.00 (381)	15.00 (381)	1916 (869)
8.75 (222)	23.45 (595)	—	14.75 (375)	10.50 (267)	1411 (640)
8.75 (222)	23.43 (595)	—	14.75 (375)	10.50 (267)	900 (409)
15.13 (384)	25.08 (637)	—	16.00 (406)	16.00 (406)	2288 (1038)
15.13 (384)	25.08 (637)	—	16.00 (406)	16.00 (406)	2288 (1038)
16.77 (426)	29.83 (758)	—	17.32 (440)	17.32 (440)	3673 (1666)

Use certified drawings for installation.

Dry weights are approximate and vary by input and ratio.

Specifications are subject to change without notice.

Dimensions may vary with housing adapter or output flange.

Important: Weights are approximate and include flywheel housing adapter and flexible input coupling.

DIMENSIONS AND WEIGHTS FOR TWIN DISC MARINE TRANSMISSIONS

(A) Vertical Offset

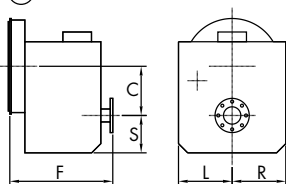

(B) Vertical Offset Downangle

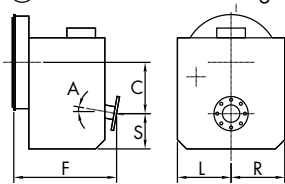

(C) Remote V-Drive

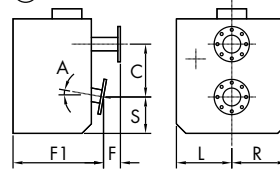

(D) Integral V-Drive

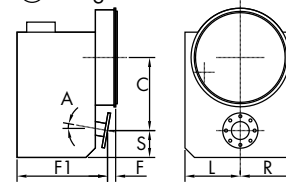

Model	Assembly Drawing	Installation Drawing Series	Con-fig.	SAE Housing	A	C (offset) in (mm)
MG-540	X-9882-C	X-9882-C	A	0, 00, Ind.	—	8.08 (205)
MG-5506	00D005604	00D005604	A	0, 00, Ind.	—	19.29 (490)
MGX-5600	1027251	1027247	A	0, 00, Ind.	—	21.65 (550)
MGX-5600 DR	1028410	1028499	A	Ind.	—	8.85 (225)
MGN-1814 V	PPD007097	PPD007097	A	Ind.	—	16.73 (425)
MGN-1816 V	PPD007098	PPD007098	A	Ind.	—	21.26 (540)
MGN-1817 V	00D007099-B	00D007099-B	A	Ind.	—	26.38 (670)
MGN-1819 V	PLN005679-B	PLN005679-B	A	Ind.	—	30.71 (780)
MG-6449 A	5-50006-B	7-38504-A	B	1, 0, Ind.	10°	10.83 (275)
MG-6449 RV	7-37431-A	7-37431-A	C	—	10°	10.88 (276)
MGX-6598 DC	7-40985	see 1025433	A	1, 0, Ind.	—	12.20 (310)
MGX-6599 SC	7-40979	7-40989	A	1, 0, Ind.	—	8.66 (220)
MGX-6599 A	7-40981	7-40987	B	1, 0, Ind.	10°	11.70 (297)
MGX-6599 RV	7-40983	7-40988	C	—	10°	11.70 (297)
MG-6600 DC	7-37941	7-36712-A	A	0, Ind.	—	14.17 (360)
MGX-6620 SC	7-40980	see 1025433	A	0, Ind.	—	9.25 (235)
MGX-6620 A	7-40982	see 1025433	B	0, Ind.	10°	12.44 (316)
MGX-6620 RV	7-40984	see 1025433	C	—	10°	12.44 (316)
MGX-6690 SC	1020674	1025142	A	0, 00, Ind.	—	12.21 (310)
MGX-6848 SC	1020675	1025142	A	0, 00, Ind.	—	12.21 (310)
MG-6984 SC	7-37482	7-38495	A	0, 00, Ind.	—	12.21 (310)
MG-6984 A	7-37950-A	7-37028	B	0, 00, Ind.	10°	15.04 (382)
MG-6984 RV	7-37042	7-37042	C	—	10°	15.04 (382)
MGX-61000 SC	1024420	1024771	A	00, Ind.	—	14.96 (380)
MG-61242 SC	7-37018	see 1025433	A	Ind.	—	13.39 (340)
MG-61242 A	7-37047	7-37046	B	Ind.	10°	17.52 (445)
MG-61242 RV	7-37050	7-37049	C	—	10°	17.52 (445)
MGX-61500 SC	1024500	1025454	A	Ind.	—	18.11 (460)
MGX-61500 SC-HL	1023610	1025259	E	Ind.	—	18.11 (460)
MGX-61500 SC-HR	1023611	1025260	F	Ind.	—	18.11 (460)

S (sump) in (mm)	F (length) in (mm)	F1 (length) in (mm)	L (mounting pad) in (mm)	R (mounting pad) in (mm)	Weight lb (kg)
13.45 (342)	36.47 (926)	—	16.00 (406)	16.00 (406)	4450 (2019)
19.29 (490)	39.17 (995)	—	20.08 (510)	20.08 (510)	4846 (2200)
21.26 (540)	41.02 (1042)	—	20.67 (525)	20.67 (525)	6890 (3132)
21.26 (540)	50.63 (1286)	—	20.67 (525)	20.67 (525)	7000 (3175)
19.69 (500)	55.12 (1400)	—	27.56 (700)	23.62 (600)	6608 (3000)
22.83 (580)	55.12 (1400)	—	29.53 (750)	29.53 (750)	8370 (3800)
27.56 (700)	55.12 (1400)	—	31.50 (800)	31.50 (800)	9912 (4500)
33.46 (850)	55.12 (1400)	—	37.40 (950)	37.40 (950)	TBA (TBA)
4.92 (125)	20.83 (529)	—	12.01 (305)	12.01 (305)	730 (331)
6.44 (164)	6.32 (161)	20.32 (516)	12.01 (305)	12.01 (305)	717 (325)
10.83 (275)	23.72 (603)	—	14.17 (360)	14.17 (360)	1278 (580)
9.29 (236)	23.31 (592)	—	13.39 (340)	13.39 (340)	1054 (478)
6.25 (159)	22.60 (574)	—	13.39 (340)	13.39 (340)	1120 (508)
6.25 (159)	6.06 (154)	20.63 (524)	13.39 (340)	13.39 (340)	1031 (468)
14.96 (380)	30.87 (784)	—	14.76 (375)	14.76 (375)	1747 (794)
9.25 (235)	27.48 (698)	—	13.39 (340)	13.39 (340)	1267 (575)
7.25 (184)	25.70 (653)	—	13.39 (340)	13.39 (340)	1278 (580)
7.25 (184)	5.06 (129)	23.74 (603)	13.39 (340)	13.39 (340)	1146 (520)
11.81 (300)	30.13 (765)	—	17.32 (440)	17.32 (440)	2205 (1001)
11.81 (300)	30.13 (765)	—	17.32 (440)	17.32 (440)	2205 (1001)
11.30 (287)	27.20 (691)	—	17.52 (445)	17.52 (445)	2628 (1192)
8.50 (216)	26.93 (684)	—	17.52 (445)	17.52 (445)	1991 (905)
8.50 (216)	11.82 (300)	30.86 (784)	17.52 (445)	17.52 (445)	2002 (910)
14.17 (360)	39.08 (993)	—	19.29 (490)	19.29 (490)	3920 (1780)
12.17 (309)	29.80 (757)	—	19.69 (500)	19.69 (500)	2310 (1050)
9.49 (241)	30.35 (771)	—	19.69 (500)	19.69 (500)	2431 (1105)
9.49 (241)	11.34 (288)	32.56 (827)	19.69 (500)	19.69 (500)	2475 (1125)
15.63 (397)	40.63 (1032)	—	18.23 (463)	18.23 (463)	4445 (2016)
24.36 (619)	40.04 (1017)	—	15.63 (397)	29.33 (745)	4840 (2195)
24.36 (619)	40.04 (1017)	—	29.33 (745)	15.63 (397)	4840 (2195)

Use certified drawings for installation.

Dry weights are approximate and vary by input and ratio.

Specifications are subject to change without notice.

Dimensions may vary with housing adapter or output flange.

Important: Weights are approximate and include flywheel housing adapter and flexible input coupling.



VETH Z-DRIVE SPECIFICATIONS

TYPE OF NOZZLE

Veth Propulsion uses two types of nozzles: VG40 and VOB50 (optimized nozzle 19A).

VOB 50 is often used with tug- and push boats. The Bollard Pull efficiency is 2-3% higher than a VG40 nozzle. VG40 is recommended when high thrust at higher speeds and sailing performances are relevant.

TYPE OF PROPELLER

An open propeller, as opposed to a nozzled propeller, is the preferred choice for speeds ranging from 12-14 knots. In the case of vessels with a top speed falling within the 10 to 20 knots range, which also require minimal noise emissions, contra-rotating (CR) propellers represent an excellent option in terms of efficiency across different speeds. CR propellers, which have emerged as a significant technological advancement in the maritime industry, are characterized by their ability to combine high efficiency, small propeller diameters, and quiet propulsion, making them a well-rounded choice for propulsion needs in these scenarios. Initially implemented on passenger vessels, their potential soon caught the attention of yacht manufacturers, leading to the development of the ELITE series.

THRUSTER FOUNDATION

RIGID WELDED SUSPENSION

The thruster can be welded into the hull of the vessel; all foundation elements will be welded as an integrated part of the vessel.

RIGID BOLTED SUSPENSION

The thrusters can be built into the vessel on a rigid suspension foundation, where the thruster is bolted directly onto the bottom well.

FLEXIBLE SUSPENSION

The thrusters can be mounted in a flexible suspension bottom well to suppress noise and vibration when operating. To create a flexible suspension, rubber isolation rings are inserted between the thruster foundation and the bottom well.

ACTIVE NOISE SUPPRESSION (ANS)

One of Veth Propulsion's solutions to keeping tunnel thruster noise levels to a minimum, besides flexible mounting of the thrusters, is by employing Active Noise Suppression by means of compressed air injection. Compressed air is injected into the thruster's tunnel in front of the propeller's direction of flow, thus minimizing the effects of cavitation.

ANS is a cost-effective way to decrease noise levels and cavitation damage in practically all new and existing tunnel thruster designs. Extensive testing has resulted in noise reductions up to 10 dB.

System activation – compressed air injected into tunnel's water flow

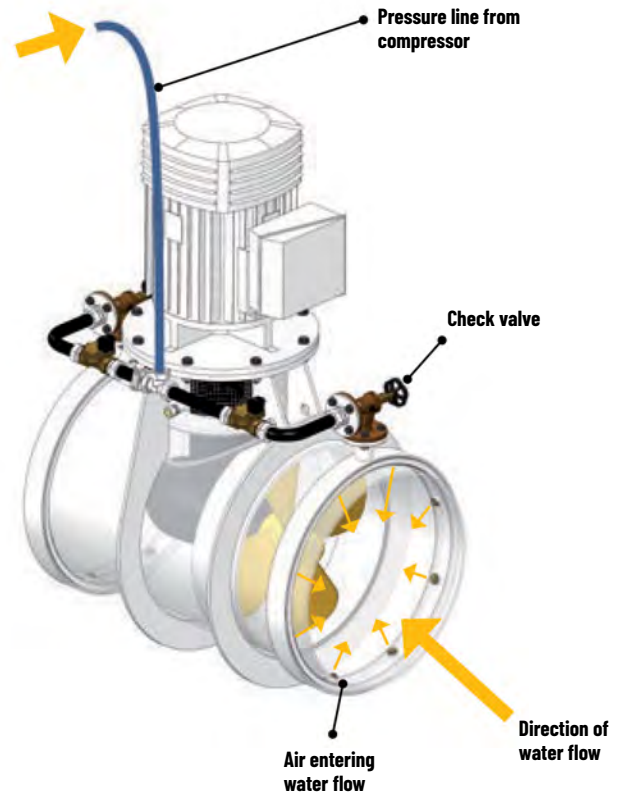

Unit	Nominal Speed (rpm)	Propeller Type	Propeller Diameter (mm)	V _{tip} (m/s)	Veth (kW)
VZ-200	1800	Open	Ø900	27	245
		Open	Ø1000	30	245
		Ducted	Ø900	27	245
VZ-320	1800	Open	Ø1100	31	330
		Ducted	Ø1050	29	330
VZ-320A	2100	Open	Ø1100	31	335
		Ducted	Ø1050	29	335
VZ-400A	1800	Open	Ø1100	32	380
		Ducted	Ø1030	30	417
VZ-400	1800	Open	Ø1250	31	470
		Ducted	Ø1130	28	470
VZ-550	1800	Open	Ø1350	31	555
		Ducted	Ø1250	29	555
VZ-700	1800	Open	Ø1500	31	707
		Ducted	Ø1400	29	716
VZ-900	1800	Open	Ø1600	29	804
		Open	Ø1700	31	908
		Ducted	Ø1600	29	968
		Ducted	Ø1700	31	968
VZ-900A	1600	Open	Ø1600	29	804
		Open	Ø1700	31	908
		Ducted	Ø1600	29	945
VZ-1100	1800	Open	Ø1900	32	1134
		Ducted	Ø1800	30	1272
		Ducted	Ø1900	32	1305
VZ-1100A	1600	Open	Ø1900	32	1134
		Ducted	Ø1800	30	1272
		Ducted	Ø1900	32	1305
VZ-1250	1800	Open	Ø2100	33	1385
		Ducted	Ø1900	30	1418
		Ducted	Ø2000	31	1425
		Ducted	Ø2100	33	1425
VZ-1250A	1600	Open	Ø2100	31	1385
		Ducted	Ø1900	28	1418
		Ducted	Ø2000	30	1425
		Ducted	Ø2100	31	1425
VZ-1250B1	1200	Open	Ø2100	29	1385
		Ducted	Ø1900	26	1418
		Ducted	Ø2000	28	1425
		Ducted	Ø2100	29	1425
VZ-1250C1	1000	Open	Ø2100	31	1385
		Ducted	Ø1900	28	1418
		Ducted	Ø2000	30	1425
		Ducted	Ø2100	31	1425
VZ-1250D1	900	Open	Ø2100	31	1385
		Ducted	Ø1900	28	1418
		Ducted	Ø2000	29	1425
		Ducted	Ø2100	31	1425
VZ-1250F1	750	Open	Ø2100	31	1385
		Ducted	Ø1900	28	1418
		Ducted	Ø2000	29	1425
		Ducted	Ø2100	31	1425

LRS (kW)		BV (kW)	ABS (kW)	RINA (kW)	DNV-GL (kW)
Inland	Seagoing				
245	210	233	207	216	165
245	210	233	207	216	165
245	210	233	207	216	165
330	320	319/330*	284/313*	297/330*	218
330	320	319/330*	284/313*	297/330*	218
335	324	319/335*	283/317*	296/335*	221
335	324	319/335*	283/317*	296/335*	221
380	380	380	380	380	350/370*
417	417	417	392/416*	410/417*	350/370*
417	417	468	416/432*	435/469*	345
417	417	468	416/432*	435/469*	345
484	484	555	555	484	420
484	484	555	555	484	420
707	624	688	616/634*	643/688*	406
716	624	688	616/634*	643/688*	406
804	804	804	804	804	741
908	908	908	908	908	741
958	958	968	968	958	741
958	958	968	968	958	741
804	804	804	804	804	731
869	869	876	869	869	731
869	869	876	869	869	731
869	869	876	869	869	731
1134	1134	1134	1118/1143*	1134	993
1272	1272	1258/1272*	1118/1243*	1168/1272*	993
1305	1305	1258/1305*	1118/1243*	1168/1305*	993
1134	1134	1134	1134	1134	988
1272	1272	1272	1272	1272	988
1305	1305	1305	1291/1305*	1305	988
1385	1385	1385	1289/1385*	1346/1385*	991
1418	1418	1418	1289/1418*	1346/1418*	991
1425	1425	1425	1289/1425*	1346/1425*	991
1425	1425	1425	1289/1425*	1346/1425*	991
1385	1385	1385	1291/1385*	1348/1385*	988
1418	1418	1418	1291/1418*	1348/1418*	988
1425	1425	1425	1291/1425*	1348/1425*	988
1425	1425	1425	1291/1425*	1348/1425*	988
1320	1320	1385	1307/1320*	1320	900
1320	1320	1418	1307/1320*	1320	900
1320	1320	1420	1307/1320*	1320	900
1320	1320	1420	1307/1320*	1320	900
1385	1385	1385	1325/1385*	1384/1385*	963
1418	1418	1418	1325/1418*	1384/1418*	963
1425	1425	1425	1325/1425*	1384/1425*	963
1425	1425	1425	1325/1425*	1384/1425*	963
1385	1385	1385	1329/1385*	1385	954
1418	1418	1418	1329/1418*	1388/1418*	954
1425	1425	1425	1329/1425*	1388/1425*	954
1425	1425	1425	1329/1425*	1388/1425*	954
1385	1385	1385	1310/1385*	1368/1385*	967
1418	1418	1418	1310/1418*	1368/1418*	967
1425	1425	1425	1310/1425*	1368/1425*	967
1425	1425	1425	1310/1425*	1368/1425*	967

Unit	Nominal Speed (rpm)	Propeller Type	Propeller Diameter (mm)	V _{tip} (m/s)	Veth (kW)
Ducted	Ø2200	31	1901		
Ducted	Ø2300	32	1920		
Ducted	Ø2400	33	1920		
VZ-1550A	1600	Open	Ø2400	33	1810
Ducted		Ø2200	30	1901	
Ducted		Ø2300	32	1920	
Ducted		Ø2400	33	1920	
VZ-1550C1	1000	Open	Ø2400	33	1810
Ducted		Ø2200	31	1901	
Ducted		Ø2300	32	1920	
Ducted		Ø2400	33	1920	
VZ-1550D1	900	Open	Ø2400	33	1810
Ducted		Ø2200	31	1901	
Ducted		Ø2300	32	1920	
Ducted		Ø2400	33	1920	
VZ-1550F1	750	Open	Ø2400	33	1810
Ducted		Ø2200	30	1901	
Ducted		Ø2300	31	1920	
Ducted		Ø2400	33	1920	
VZ-1800	1800	Open	Ø2600	34	2124
Ducted		Ø2400	31	2262	
Ducted		Ø2500	32	2350	
Ducted		Ø2600	34	2350	
VZ-1800A	1600	Open	Ø2600	33	2124
Ducted		Ø2400	31	2262	
Ducted		Ø2500	32	2350	
Ducted		Ø2600	33	2350	
VZ-1800B	1500	Open	Ø2600	33	2124
Ducted		Ø2400	31	2262	
Ducted		Ø2500	32	2350	
Ducted		Ø2600	33	2350	
VZ-1800D1	1200	Open	Ø2600	34	2124
Ducted		Ø2400	31	2262	
Ducted		Ø2500	33	2350	
Ducted		Ø2600	34	2350	
VZ-1800F1	1000	Open	Ø2600	33	2124
Ducted		Ø2400	31	2262	
Ducted		Ø2500	32	2350	
Ducted		Ø2600	33	2350	
VZ-1800G1	900	Open	Ø2600	33	2124
Ducted		Ø2400	31	2262	
Ducted		Ø2500	32	2350	
Ducted		Ø2600	33	2350	
VZ-1800H1	750	Open	Ø2600	33	2124
Ducted		Ø2400	31	2262	
Ducted		Ø2500	32	2350	
Ducted		Ø2600	33	2350	

1 Concept design only; delivery time on request.

* Number applies when the upper and/or lower gears are shotpeened.

LRS (kW)		BV (kW)	ABS (kW)	RINA (kW)	DNV-GL (kW)
Inland	Seagoing				
1810	1810	1810	1753/1810*	1810	1354
1901	1901	1901	1753/1901*	1830/1901*	1354
1920	1920	1920	1753/1920*	1830/1920*	1354
1920	1920	1920	1753/1920*	1830/1920*	1354
1810	1810	1810	1746/1810*	1822/1810*	1348
1901	1901	1901	1746/1901*	1822/1901*	1348
1920	1913	1920	1746/1920*	1822/1920*	1348
1920	1913	1920	1746/1920*	1822/1920*	1348
1810	1810	1810	1737/1810	1814/1810	1301
1901	1901	1901	1737/1901	1814/1901	1301
1920	1920	1920	1737/1915	1814/1920	1301
1920	1920	1920	1737/1915	1814/1920	1301
1810	1810	1810	1755/1810	1810	1315
1901	1901	1901	1755/1901	1832/1901	1315
1920	1920	1920	1755/1920	1832/1920	1315
1920	1920	1920	1755/1920	1832/1920	1315
1810	1810	1810	1718/1810	1793/1810	1285
1901	1901	1901	1718/1891	1793/1901	1285
1920	1920	1920	1718/1891	1793/1920	1285
1920	1920	1920	1718/1891	1793/1920	1285
2124	2124	2124	2124	2124	1731
2262	2262	2262	2256/2262*	2262	1731
2350	2350	2350	2256/2350*	2350	1731
2350	2350	2350	2256/2350*	2350	1731
2124	2124	2124	2124	2124	1741
2262	2262	2262	2249/2262*	2262	1741
2350	2350	2350	2249/2350*	2347/2350*	1741
2350	2350	2350	2249/2350*	2347/2350*	1741
2124	2124	2124	2124	2124	1787
2262	2262	2262	2240/2262*	2262	1787
2350	2350	2350	2240/2350*	2338/2350*	1787
2350	2350	2350	2240/2350*	2338/2350*	1787
2124	2124	2124	2112/2124*	2124	1592
2262	2262	2262	2112/2262*	2206/2262*	1592
2350	2350	2350	2112/2350*	2206/2350*	1592
2350	2350	2350	2112/2350*	2206/2350*	1592
2124	2124	2124	2124	2124	1758
2262	2262	2262	2244/2262*	2262	1758
2350	2350	2350	2244/2350*	2343/2350*	1758
2350	2350	2350	2244/2350*	2343/2350*	1758
2124	2124	2124	2124	2124	1740
2262	2262	2262	2223/2262*	2262	1740
2350	2350	2350	2223/2350*	2320/2350*	1740
2350	2350	2350	2223/2350*	2320/2350*	1740
2124	2124	2124	2124	2124	1757
2262	2262	2262	2244/2262*	2262	1757
2350	2350	2350	2244/2350*	2343/2350*	1757
2350	2350	2350	2244/2350*	2343/2350*	1757

Ratings are in kilowatts (kW) and are based on both maximum blade load (400 kW/m² for open propeller and 500 kW/m² for ducted propellers) and maximum machinery power.

Unit	Nominal Speed (rpm)	Propeller Diameter (mm)		V _{tip} (m/s)	Veth (kW)
		Front	Aft		
VZ-160-CR	1800	Ø850	Ø585	28	155
VZ-250-CR	1800	Ø850	Ø765	27	325
VZ-250A-CR	2100	Ø850	Ø765	28	329
VZ-450-CR	1800	Ø1100	Ø990	25	475
		Ø1200	Ø1080	27	475
VZ-700-CR	1800	Ø1350	Ø1215	25	737
VZ-900-CR	1800	Ø1400	Ø1260	25	975
		Ø1450	Ø1305	26	995
		Ø1500	Ø1350	27	995
VZ-900A-CR	1600	Ø1400	Ø1260	25	938
		Ø1450	Ø1305	25	938
		Ø1500	Ø1350	26	938
VZ-1250-CR	1800	Ø1650	Ø1485	28	1355
		Ø1700	Ø1530	29	1425
VZ-1250A-CR	1600	Ø1650	Ø1485	30	1355
		Ø1700	Ø1530	31	1425
VZ-1550-CR	1800	Ø1900	Ø1710	28	1800
		Ø2000	Ø1800	30	2000

LRS (kW)		BV (kW)	ABS (kW)	RINA (kW)	DNV-GL (kW)
Inland	Seagoing				
On request	On request	On request	On request	On request	On request
341	285	312	279/288*	292/312*	174
350	289	317	283/292*	295/317*	176
435	435	441/475*	392/432*	410/435*	325
435	435	441/475*	392/432*	410/435*	325
694	694	677	611	637	632
958	958	975	933	958	636
958	958	985	933	958	636
958	958	985	933	958	636
869	869	876	869	869	627
869	869	876	869	869	627
869	869	876	869	869	627
1355	1355	1355	1256/1355*	1311/1355*	917
1395	1395	1390	1256/1383*	1311/1390*	917
1355	1355	1355	1355	1355	1010
1425	1425	1425	1377/1425*	1425	1010
1800	1800	1800	1735/1800*	1800	1341
1967	1967	1949/2000*	1735/1910*	1811/1967*	1341

* Number applies when the upper and/or lower gears are shotpeened.
 Ratings are in kilowatts (kW) and are based on both maximum blade load (350 kW/m² for contra-rotating propellers, 400 kW/m² for open propellers and 500 kW/m² for ducted propellers) and maximum machinery power.

MAIN PROPULSION RATINGS ELECTRIC-DRIVEN Z-DRIVES



Unit	Nominal Speed (rpm)	Propeller Type	Propeller Diameter (mm)	V _{tip} (m/s)	Veth (kW)	LRS (kW)		BV (kW)	ABS (kW)	RINA (kW)	DNV-GL (kW)
						Inland	Seagoing				
VZ-200	1800	Open	Ø900	27	254	254	248	254	245	254	165
		Open	Ø1000	30	265	265	248	260	245	260	165
		Ducted	Ø900	27	265	265	248	260	245	260	165
VZ-320	1800	Open	Ø1100	31	330	330	330	330	330	330	235
		Ducted	Ø1050	29	330	330	330	330	330	330	235
		Open	Ø1250	32	470	470	470	470	470	470	345
VZ-400	1800	Ducted	Ø1130	30	470	470	470	470	470	470	345
		Open	Ø1100	31	380	380	380	380	380	380	370
VZ-400A	1800	Ducted	Ø1030	28	417	417	417	417	417	417	370
		Open	Ø1350	31	555	555	555	555	555	555	420
VZ-550	1800	Ducted	Ø1250	29	555	555	555	555	555	555	420
		Open	Ø1500	31	707	707	707	707	707	707	479
VZ-700	1800	Ducted	Ø1400	29	770	770	738	740	735	740	479
		Open	Ø1600	29	804	804	804	804	804	804	800
VZ-900	1800	Open	Ø1700	31	908	908	908	908	908	908	800
		Ducted	Ø1600	29	968	968	968	968	968	968	800
		Ducted	Ø1700	31	968	968	968	968	968	968	800
		Open	Ø1600	29	804	804	804	804	804	804	790
		Open	Ø1700	31	908	908	908	908	869	908	790
VZ-900A	1600	Ducted	Ø1600	29	945	945	945	945	869	945	790
		Ducted	Ø1700	31	945	945	945	945	869	945	790
		Open	Ø1900	32	1134	1134	1134	1134	1134	1134	1110
		Ducted	Ø1800	30	1272	1272	1272	1272	1272	1272	1110
VZ-1100	1800	Ducted	Ø1900	32	1305	1305	1305	1305	1305	1305	1110
		Open	Ø1900	32	1134	1134	1134	1134	1134	1134	1110
		Ducted	Ø1800	30	1272	1272	1272	1272	1272	1272	1110
VZ-1100A	1600	Ducted	Ø1900	32	1305	1305	1305	1305	1305	1305	1110
		Open	Ø2100	33	1385	1385	1385	1385	1385	1385	1171
		Ducted	Ø1900	30	1418	1418	1418	1418	1418	1418	1171
VZ-1250	1800	Ducted	Ø2000	31	1425	1425	1425	1425	1425	1425	1171
		Ducted	Ø2100	33	1425	1425	1425	1425	1425	1425	1171
		Open	Ø2100	31	1385	1385	1385	1385	1385	1385	1168
		Ducted	Ø1900	28	1418	1418	1418	1418	1418	1418	1168
VZ-1250A	1600	Ducted	Ø2000	30	1425	1425	1425	1425	1425	1425	1168
		Ducted	Ø2100	31	1425	1425	1425	1425	1425	1425	1168
		Open	Ø2400	33	1810	1810	1810	1810	1810	1810	1601
		Ducted	Ø2200	31	1901	1901	1901	1901	1901	1901	1601
VZ-1550	1800	Ducted	Ø2300	32	1920	1920	1920	1920	1920	1920	1601
		Ducted	Ø2400	33	1920	1920	1920	1920	1920	1920	1601
		Open	Ø2400	33	1810	1810	1810	1810	1810	1810	1500
		Ducted	Ø2200	30	1901	1901	1901	1901	1901	1901	1500
VZ-1550A	1600	Ducted	Ø2300	32	1920	1920	1920	1920	1920	1920	1500
		Ducted	Ø2400	33	1920	1920	1920	1920	1920	1920	1500
		Open	Ø2400	33	1810	1810	1810	1810	1810	1810	1500
		Ducted	Ø2200	30	1901	1901	1901	1901	1901	1901	1500

* Number applies when the upper and/or lower gears are shotpeened.
Ratings are in kilowatts (kW) and are based on both maximum blade load (400 kW/m² for open propellers and 500 kW/m² for ducted propellers) and maximum machinery power.

MAIN PROPULSION RATINGS ELECTRIC-DRIVEN Z-DRIVES



Unit	Nominal Speed (rpm)	Propeller Type	Propeller Diameter (mm)	V _{tip} (m/s)	Veth (kW)	LRS (kW)		BV (kW)	ABS (kW)	RINA (kW)	DNV-GL (kW)
						Inland	Seagoing				
VZ-1800	1800	Open	Ø2600	34	2124	2124	2124	2124	2124	2124	2045
		Ducted	Ø2400	31	2262	2262	2262	2262	2262	2262	2045
		Ducted	Ø2500	32	2350	2350	2350	2350	2350	2350	2045
		Ducted	Ø2600	34	2350	2350	2350	2350	2350	2350	2045
VZ-1800A	1600	Open	Ø2600	33	2124	2124	2124	2124	2124	2124	1815
		Ducted	Ø2400	31	2262	2262	2262	2262	2262	2262	1815
		Ducted	Ø2500	32	2350	2350	2350	2350	2350	2350	1815
		Ducted	Ø2600	33	2350	2350	2350	2350	2350	2350	1815
VZ-1800B	1500	Open	Ø2600	33	2124	2124	2124	2124	2124	2124	1815
		Ducted	Ø2400	31	2262	2262	2262	2262	2262	2262	1815
		Ducted	Ø2500	32	2350	2350	2350	2350	2350	2350	1815
		Ducted	Ø2600	33	2350	2350	2350	2350	2350	2350	1815

Ratings are in kilowatts (kW) and are based on both maximum blade load (400 kW/m² for open propeller and 500 kW/m² for ducted propellers) and maximum machinery power.

MAIN PROPULSION RATINGS ELECTRIC-DRIVEN Z-DRIVES (CR)



Unit	Nominal Speed (rpm)	Propeller Diameter (mm)		V _{tip} (m/s)	Veth (kW)
		Front	Aft		
VZ-160-CR	1800	Ø650	Ø585	28	155
VZ-250-CR	1800	Ø850	Ø765	27	345
VZ-450-CR	1800	Ø1100	Ø990	25	480
		Ø1200	Ø1080	27	480
VZ-700-CR	1800	Ø1350	Ø1215	25	834
VZ-900-CR	1800	Ø1400	Ø1260	25	975
		Ø1450	Ø1305	26	995
		Ø1500	Ø1350	27	995
VZ-900A-CR	1600	Ø1400	Ø1260	25	938
		Ø1450	Ø1305	25	938
		Ø1500	Ø1350	26	938
VZ-1250-CR	1800	Ø1650	Ø1485	28	1355
		Ø1700	Ø1530	29	1425
VZ-1250A-CR	1600	Ø1650	Ø1485	30	1355
		Ø1700	Ø1530	31	1425
VZ-1550-CR	1800	Ø1900	Ø1710	28	1800
		Ø2000	Ø1800	30	2000

LRS (kW)		BV (kW)	ABS (kW)	RINA (kW)	DNV-GL (kW)
Inland	Seagoing				
On request	On request	On request	On request	On request	On request
345	336	345	345	345	205
475	475	475	470	475	325
475	475	475	470	475	325
802	802	783	783	783	747
975	975	975	975	975	752
995	995	995	978	995	752
995	995	995	978	995	752
938	938	938	869	938	742
938	938	938	869	938	742
938	938	938	869	938	742
1355	1355	1355	1355	1355	1084
1425	1425	1425	1425	1425	1084
1355	1355	1355	1355	1355	1193
1425	1425	1425	1425	1425	1193
1800	1800	1800	1800	1967	1584
1967	1967	2000	2000	1967	1584

Ratings are in kilowatts (kW) and are based on both maximum blade load (350 kW/m² for contra-rotating propellers) and maximum machinery power.

Unit	Nominal Speed (rpm)	Propeller Type	Propeller Diameter (mm)	V _{tip} (m/s)	Veth (kW)
VL-50	1800	Open	Ø450	29	61
		Ducted	Ø450	29	61
VL-90	1800	Open	Ø600	30	113
		Open	Ø650	33	133
		Ducted	Ø600	30	140
		Ducted	Ø600	30	140
VL-180	1500	Open	Ø800		168
	1800	Open	Ø700	29	154
		Ducted	Ø700	29	192
VL-200	1500	Open	Ø900	38	254
		Open	Ø1000	43	265
		Ducted	Ø900	27	265
VL-320	1500	Open	Ø1100	31	370
		Ducted	Ø1050	30	370
VL-400A	1200	Open	Ø1100	33	380
		Ducted	Ø1030	31	417
VL-400	1500	Open	Ø1250	34	491
		Ducted	Ø1130	30	500
VL-550	900	Open	Ø1350	29	533
		Ducted	Ø1250	27	533
VL-550	1000	Open	Ø1350	32	555
		Ducted	Ø1250	30	555
VL-550	1500	Open	Ø1350	30	517
		Ducted	Ø1250	28	517
VL-700	1000	Open	Ø1500	32	707
		Ducted	Ø1400	30	760
VL-700	1500	Open	Ø1500	33	650
		Ducted	Ø1400	31	650
VL-900	900	Open	Ø1600	32	804
		Open	Ø1700	34	908
		Ducted	Ø1600	32	968
		Ducted	Ø1700	34	968
		Ducted	Ø1700	34	968
VL-1100	900	Open	Ø1900	33	1134
		Ducted	Ø1800	31	1272
		Ducted	Ø1900	33	1305
VL-1250	900	Open	Ø2100	32	1385
		Ducted	Ø1900	29	1418
		Ducted	Ø2000	31	1425
		Ducted	Ø2100	32	1425
VL-1550	750	Open	Ø2400	34	1810
		Ducted	Ø2200	31	1901
		Ducted	Ø2300	32	1920
		Ducted	Ø2400	34	1920
VL-1800	750	Open	Ø2600	32	2124
		Ducted	Ø2400	30	2262
		Ducted	Ø2500	31	2306
		Ducted	Ø2600	32	2306

LRS (kW)		BV (kW)	ABS (kW)	RINA (kW)	DNV-GL (kW)
Inland	Seagoing				
61	61	57	57	57	36
61	61	57	57	57	36
113	113	113	113	113	104/105*
133	133	133	133	133	104/105*
140	140	140	133/140*	138/140*	104/105*
168	152	168	167	168	114
154	154	154	154	154	137
192	183	192	192	192	137
254	250	254	254	254	178
265	250	265	265	265	178
265	250	265	265	265	178
370	370	370	370	370	260
370	370	370	370	370	260
380	380	380	380	380	380
417	417	417	417	417	417
491	491	491	491	491	375
500	500	500	500	500	375
533	533	533	533	533	398
533	533	533	533	533	398
555	555	555	555	555	442
555	555	555	555	555	442
540	429	517	500	543	354
540	429	517	500	543	354
707	707	707	707	707	490
770	762	760	760	760	490
681	542	650	628	682	495
681	542	650	628	682	495
804	804	804	804	804	804
908	908	908	908	908	865
968	968	968	968	968	865
968	968	968	968	968	865
1134	1134	1134	1134	1134	1134
1272	1272	1272	1272	1272	1140
1305	1305	1305	1305	1305	1140
1385	1385	1385	1385	1385	1355
1418	1418	1418	1418	1418	1355
1425	1425	1425	1425	1425	1355
1425	1425	1425	1425	1425	1355
1810	1810	1810	1810	1810	1801
1901	1901	1901	1901	1901	1801
1920	1920	1920	1920	1920	1801
1920	1920	1920	1920	1920	1801
2124	2124	2124	2124	2124	2049
2262	2262	2262	2262	2262	2049
2306	2306	2306	2306	2306	2049
2306	2306	2306	2306	2306	2049

* Number applies when the upper and/or lower gears are shotpeened.
Ratings are in kilowatts (kW) and are based on both maximum blade load (400 kW/m² for open propeller and 500 kW/m² for ducted propellers) and maximum machinery power.

Unit	Nominal Speed (rpm)	Propeller Diameter (mm)		V _{0p} (m/s)	Veth (kW)
		Front	Aft		
VL-160-CR	1500	Ø650	Ø585	28	183
VL-250-CR	1500	Ø850	Ø765	27	350
VL-450-CR	1200	Ø1100	Ø990	25	500
		Ø1200	Ø1080	27	500
VL-700-CR	900	Ø1350	Ø1210	28	850
VL-900-CR	900	Ø1400	Ø1260	27	975
		Ø1450	Ø1305	28	1000
		Ø1500	Ø1350	29	1000
VL-1250-CR	1000	Ø1650	Ø1485	28	1355
		Ø1700	Ø1530	29	1425
VL-1550-CR	750	Ø1900	Ø1710	29	1800
		Ø2000	Ø1800	30	2000

LRS (kW)		BV (kW)	ABS (kW)	RINA (kW)	DNV-GL (kW)
Inland	Seagoing				
On request	On request	On request	On request	On request	On request
350	339	350	347	350	164
500	500	500	500	500	500
500	500	500	500	500	500
850	850	850	850	850	816
975	975	975	975	975	811
1000	1000	1000	1000	1000	811
1000	1000	1000	1000	1000	811
1355	1355	1355	1355	1355	1098
1425	1425	1425	1425	1425	1098
1800	1800	1800	1800	1800	1609
2000	2000	2000	2000	2000	1609

Ratings are in kilowatts (kW) and are based on both maximum blade load (350 kW/m² for contra-rotating propellers) and maximum machinery power.

MAIN PROPULSION RATINGS L-DRIVES: (SEMI) INTEGRATED



Unit	Nominal Speed (rpm)	Propeller Type	Propeller Diameter (mm)	V _{tip} (m/s)	Veth (kW)
VL-90si	1500	Open	Ø600	30	113
		Open	Ø650	33	133
		Nozzled	Ø600	30	140
VL-180si	1500	Open	Ø700	24	154
		Open	Ø800	24	168
		Ducted	Ø700	27	168
	1800	Open	Ø700	29	154
		Open	Ø800	33	201
		Ducted	Ø700	29	192
VL-200si	1500	Open	Ø900	27	254
		Open	Ø1000	31	267
		Ducted	Ø900	27	267
VL-320si	1500	Open	Ø1100	31	370
		Ducted	Ø1050	30	370
VL-400si	1500	Open	Ø1250	34	491
		Ducted	Ø1130	30	500
VL-550si	900	Open	Ø1250	27	533
	1000	Ducted	Ø1130	27	555
VL-550i	900	Open	Ø1350	29	533
		Ducted	Ø1250	27	533
VL-700i	1000	Open	Ø1500	32	707
		Ducted	Ø1400	30	760
VL-900i	900	Open	Ø1600	32	804
		Open	Ø1700	34	908
		Ducted	Ø1600	32	968
		Ducted	Ø1700	34	968
		Open	Ø1900	33	1134
VL-1100i	900	Ducted	Ø1800	31	1272
		Ducted	Ø1900	33	1305
		Open	Ø2100	32	1385
VL-1250i	900	Ducted	Ø1900	29	1418
		Ducted	Ø2000	31	1425
		Ducted	Ø2100	32	1425
		Open	Ø2400	34	1810
VL-1550i	750	Ducted	Ø2200	31	1901
		Ducted	Ø2300	32	1920
		Ducted	Ø2400	34	1920
		Open	Ø2600	32	2124
VL-1800i	750	Ducted	Ø2400	30	2262
		Ducted	Ø2500	31	2306
		Ducted	Ø2600	32	2306
		Open	Ø2600	32	2306

LRS (kW)		BV (kW)	ABS (kW)	RINA (kW)	DNV-GL (kW)
Inland	Seagoing				
113	113	113	113	113	97/102*
133	133	133	133	133	97/102*
140	140	140	133/140*	139	97/102*
154	152	154	154	154	114
168	152	168	168	168	114
168	152	168	168	168	114
154	154	154	154	154	137
201	183	201	201	201	137
192	183	192	192	192	137
254	250	254	254	254	178
267	250	267	267	267	178
267	250	267	267	267	178
370	370	370	370	370	260
370	370	370	370	370	260
491	491	491	491	491	375
500	500	500	500	500	375
533	533	533	533	533	398
555	555	555	555	555	442
533	533	533	533	533	398
533	533	533	533	533	398
707	707	707	707	707	490
760	760	760	760	760	490
804	804	804	804	804	804
908	908	908	908	908	865
968	968	968	968	968	865
968	968	968	968	968	865
1134	1134	1134	1134	1134	1134
1272	1272	1272	1272	1272	1140
1305	1305	1305	1305	1305	1140
1385	1385	1385	1385	1385	1355
1418	1418	1418	1418	1418	1355
1425	1425	1425	1425	1425	1355
1425	1425	1425	1425	1425	1355
1810	1810	1810	1810	1810	1801
1901	1901	1901	1901	1901	1801
1920	1920	1920	1920	1920	1801
1920	1920	1920	1920	1920	1801
2124	2124	2124	2124	2124	2049
2262	2262	2262	2262	2262	2049
2306	2306	2306	2306	2306	2049
2306	2306	2306	2306	2306	2049

Ratings are in kilowatts (kW) and are based on both maximum blade load (400 kW/m² for open propeller and 500 kW/m² for ducted propellers) and maximum machinery power.

MAIN PROPULSION RATINGS L-DRIVES: (SEMI) INTEGRATED (CR)



Unit	Nominal Speed (rpm)	Propeller Diameter (mm)		V _{tip} (m/s)	Veth (kW)
		Front	Aft		
VL-160si-CR	1500	Ø650	Ø585	28	166
VL-250si-CR	1500	Ø850	Ø765	27	350
VL-450si-CR	1200	Ø1100	Ø990	25	500
		Ø1200	Ø1080	27	500
VL-700i-CR	900	Ø1350	Ø1210	28	600
VL-720i-CR	900	Ø1350	Ø1210	28	850
VL-900i-CR	900	Ø1400	Ø1260	27	975
		Ø1450	Ø1305	28	1000
		Ø1500	Ø1350	29	1000
VL-1250i-CR	1000	Ø1650	Ø1450	28	1355
		Ø1700	Ø1530	29	1425
VL-1550i-CR	750	Ø1900	Ø1710	29	1800
		Ø2000	Ø1800	30	2000
VL-2550i-CR		Ø2500	Ø2250		3000

LRS (kW)		BV (kW)	ABS (kW)	RINA (kW)	DNV-GL (kW)
Inland	Seagoing				
166	152	166	160	166	134
350	339	350	347	350	227
500	500	500	500	500	500
500	500	500	500	500	500
600	600	600	600	600	600
850	850	850	850	850	816
975	975	975	975	975	811
1000	1000	1000	1000	1000	811
1000	1000	1000	1000	1000	811
1355	1355	1355	1355	1355	1098
1425	1425	1425	1425	1425	1098
1800	1800	1800	1800	1800	1609
2000	2000	2000	2000	2000	1609
		3000			

Ratings are in kilowatts (kW) and are based on both maximum blade load (350 kW/m² for contra-rotating propellers) and maximum machinery power.

AUXILIARY POWER UNIT RATINGS DIESEL-DRIVEN VETH JET

Unit	Nominal Speed (rpm)	Propeller Diameter (mm)	V _{tip} (m/s)	Veth (kW)
K-800	1800	Ø780	24	191
K-1000	1800	Ø980	30	283
K-1000NR	2100	Ø980	32	280
K-1200	1800	Ø1180	28	404
K-1300	1800	Ø1280	30	478
K-1300A	2100	Ø1280	30	577
K-1400	1800	Ø1420	27	618
K-1400A	1800	Ø1420	30	550
K-1400B	1800	Ø1420	33	478
K-1400NR	1500	Ø1420	28	618
K-1650	1800	Ø1650	31	1062
K-1800	1800	Ø1800	30	1257

LRS (kW)		BV (kW)	ABS (kW)	RINA (kW)	DNV-GL (kW)
Inland	Seagoing				
191	191	191	191	191	191
283	283	283	283	283	283
280	280	225	280	280	280
404	404	235	404	404	300
478	478	437	478	478	308
577	577	459	577	500	403
618	618	618	618	500	510
550	550	532	550	500	384
478	478	437	478	478	308
618	618	618	618	500	448
1030	1030	1005	1005	949	797
1257	1257	1257	1257	1257	1000

AUXILIARY POWER UNIT RATINGS ELECTRIC-DRIVEN VETH JET

Unit	Nominal Speed (rpm)	Propeller Diameter (mm)	V _{tip} (m/s)	Veth (kW)
K-800	1800	Ø780	24	191
K-800V	1800	Ø780	24	191
K-1000	1800	Ø980	30	283
K-1000NR	2100	Ø980	32	280
K-1000V	1800	Ø980	30	283
K-1200	1800	Ø1180	28	404
K-1200V	1800	Ø1180	28	404
K-1300	1800	Ø1280	30	478
K-1300V	1800	Ø1280	30	487
K-1300A	2100	Ø1280	30	577
K-1400	1800	Ø1420	27	618
K-1400A	1800	Ø1420	30	550
K-1400NR	1500	Ø1420	28	618
K-1400B	1800	Ø1420	33	478
K-1400BV	1800	Ø1420	34	487
K-1650	1800	Ø1650	31	1062
K-1800	1800	Ø1800	30	1257

LRS (kW)		BV (kW)	ABS (kW)	RINA (kW)	DNV-GL (kW)
Inland	Seagoing				
191	191	191	191	191	191
191	191	191	191	191	191
283	283	283	283	283	283
280	280	225	280	280	280
283	283	283	283	283	283
404	404	372	404	404	300
404	404	404	404	404	300
478	478	478	478	478	365
487	487	487	487	487	300
577	577	577	577	500	450
618	618	618	618	500	510
550	550	550	550	500	454
618	618	618	618	500	510
478	478	478	478	478	365
478	478	478	478	478	300
1062	1062	1062	1062	1062	900
1257	1257	1257	1257	1257	1000

Ratings are in kilowatts (kW) and are based on both maximum blade load (500 kW/m²) and maximum machinery power.

AUXILIARY POWER UNIT RATINGS

DIESEL-DRIVEN
COMPACT JET (CJ)



Unit	Nominal Speed (rpm)	Propeller Diameter (mm)	V _{tip} (m/s)	Veth (kW)
CJ-800	1800	Ø840	27	225
	2000	Ø840	30	225
CJ-1000	1800	Ø1040	27	340
	2000	Ø1040	31	340
CJ-1200	1800	Ø1240	30	483
	2000	Ø1240	33	483
CJ-1400	1800	Ø1400	29	616

LRS (kW)		BV (kW)	ABS (kW)	RINA (kW)	DNV-GL (kW)
Inland	Seagoing				
225	225	225	225	225	225
225	225	225	225	225	225
330	330	340	340	340	300
340	340	340	340	340	340
483	483	450	483	483	300
483	483	483	483	483	300
616	616	600	616	600	490

AUXILIARY POWER UNIT RATINGS

ELECTRIC-DRIVEN
COMPACT JET (CJ)

Unit	Nominal Speed (rpm)	Propeller Diameter (mm)	V _{tip} (m/s)	Veth (kW)
CJ-800	1800	Ø840	28	225
	2000	Ø840	30	225
CJ-800V	1800	Ø840	30	225
CJ-1000	1800	Ø1040	27	340
	2000	Ø1040	31	340
CJ-1000V	1800	Ø1040	28	340
CJ-1200	1800	Ø1240	30	483
	2000	Ø1240	33	483
CJ-1200V	1000	Ø1240	31	483
CJ-1400	1800	Ø1400	29	616
CJ-1400V	1000	Ø1400	30	616

LRS (kW)		BV (kW)	ABS (kW)	RINA (kW)	DNV-GL (kW)
Inland	Seagoing				
225	225	225	225	225	225
225	225	225	225	225	225
225	225	225	225	225	225
340	340	340	340	340	300
340	340	340	340	340	340
340	340	340	340	340	300
483	483	483	483	483	300
483	483	483	483	483	300
483	483	483	483	483	300
616	616	600	616	600	579
616	616	616	616	616	598

AUXILIARY POWER UNIT RATINGS

VETH COMPACT GRID (VCG)

Unit	Nominal Speed (rpm)	Propeller Diameter (mm)	V _{tip} (m/s)	Veth (kW)
VCG-400	1500	Ø400	31	50
VCG-600	1000	Ø580	30	99
VCG-750	750	Ø750	29	177

LRS (kW)		BV (kW)	ABS (kW)	RINA (kW)	DNV-GL (kW)
Inland	Seagoing				
50	50	50	50	50	50
99	99	99	99	99	99
177	177	177	177	177	177

Ratings are in kilowatts (kW) and are based on both maximum blade load (500 kW/m²) and maximum machinery power.

AUXILIARY POWER UNIT RATINGS

DIESEL-DRIVEN
STEERING GRID



Unit	Nominal Speed (rpm)	Propeller Diameter (mm)	V _{tip} (m/s)	Veth (kW)
VSG-800	1800	Ø780	24	191
VSG-1000(L)	1800	Ø980	30	283
VSG-1200(L)	1800	Ø1180	28	404
VSG-1300(L)	1800	Ø1280	30	478
VSG-1300A	2100	Ø1280	30	577
VSG-1400	1800	Ø1420	30	478

Ratings are in kilowatts (kW) and are based on both maximum blade load (500 kW/m²) and maximum machinery power.

LRS (kW)		BV (kW)	ABS (kW)	RINA (kW)	DNV-GL (kW)
Inland	Seagoing				
191	191	191	191	191	191
283	283	283	283	283	283
404	404	235	404	404	300
478	478	437	478	478	308
577	577	559	577	500	403
478	478	437	478	478	308

AUXILIARY POWER UNIT RATINGS

ELECTRIC-DRIVEN
STEERING GRID

Unit	Nominal Speed (rpm)	Propeller Diameter (mm)	V _{tip} (m/s)	Veth (kW)
VSG-800	1800	Ø780	24	191
VSG-1000(L)	1800	Ø980	30	283
VSG-1000V	1800	Ø980	30	283
VSG-1200(L)	1800	Ø1180	28	404
VSG-1200V	1800	Ø1180	28	404
VSG-1300(L)	1800	Ø1280	30	478
VSG-1300V	1800	Ø1280	30	487
VSG-1300A	2100	Ø1280	30	577
VSG-1400	1800	Ø1420	30	478
VSG-1400B	1800	Ø1420	33	478
VSG-1400BV	1800	Ø1420	33	478
VSG-1400	1800	Ø1420	27	618

Ratings are in kilowatts (kW) and are based on both maximum blade load (500 kW/m²) and maximum machinery power.

LRS (kW)		BV (kW)	ABS (kW)	RINA (kW)	DNV-GL (kW)
Inland	Seagoing				
191	191	191	191	191	191
283	283	283	283	283	283
283	283	283	283	283	283
404	404	372	404	404	300
404	404	404	404	404	300
478	478	478	478	478	365
487	487	487	487	487	300
577	577	577	577	500	450
478	478	478	478	478	365
478	478	478	478	478	365
478	478	478	478	478	300
618	618	618	618	500	510

AUXILIARY POWER UNIT RATINGS

TUNNEL THRUSTERS

Unit	Nominal Speed (rpm)	Propeller Diameter (mm)	V _{tip} (m/s)	Veth (kW)
VT-50	1800	Ø450	29	64
VT-90	1800	Ø600	30	113
		Ø650	33	133
VT-180	1500	Ø850	29	168
	1800	Ø800	33	201
VT-240	1500	Ø980	30	267
VT-320	1500	Ø1050	30	350
VT-400	1500	Ø1200	32	452
VT-550	1500	Ø1350	30	545
VT-700	1000	Ø1500	32	707
VT-700	1500	Ø1500	33	707
VT-900	750	Ø1800	30	966
VT-900	1500	Ø1600	29	804
		Ø1700	31	908
VT-1250	900	Ø2100	32	1385

* Number applies when the upper and/or lower gears are shotpeened.

LRS (kW)		BV (kW)	ABS (kW)	RINA (kW)	DNV-GL (kW)
Inland	Seagoing				
64	64	64	64	64	64
113	113	113	113	113	113
133	133	133	133	133	133
168	168	168	168	168	168
201	201	201	201	201	201
267	267	267	267	267	267
350	350	350	350	350	301
452	452	452	452	452	452
545	545	545	545	545	500
707	707	707	707	707	624
707	707	707	707	707	543
966	966	966	966	966	966
804	804	804	804	804	804
908	908	908	908	908	876
1385	1385	1385	1385	1385	1385

Ratings are in kilowatts (kW) and are based on both maximum blade load (400 kW/m²) and maximum machinery power.

GLOBAL SERVICE

The Twin Disc Global Customer Support Program is committed to providing world-class support in the most efficient and consistent manner for all of our customers. Our regional sales offices and vast distribution network support Twin Disc products all over the world. With a corporate presence in every major market region, and our extensive and growing worldwide network of more than 250 distributor sales and service locations in 83 countries, you can rest assured you're never far from Twin Disc support.

Our program offers a wide range of services from the sales process through commissioning and eventually, upgrade. Twin Disc experts are always available, wherever you are, to help you obtain the best possible return on your investment in our products.



- Twin Disc
- Veth Propulsion
- HQ/Subsidiaries



Click for the most current locations of our Global Service Network

Training curriculum provided by the Twin Disc Global Customer Support Program is developed utilizing the latest information and is built upon decades of expertise. Group training in a classroom setting as well as hands-on training with electrical, mechanical and spin test stands provide the most in-depth training for all of our global technicians.

With our vast network of distributor and dealer locations around the world, Twin Disc offers you unprecedented service support. We can put engineering and service expertise on location virtually anywhere. We'll work with you on your particular application and product to ensure optimum results. We're more than just a name you know, Twin Disc is a name you can trust.

Wherever you are when you need support, simply call your local Twin Disc distributor. To find your nearest distributor, go to www.twindisc.com.



TWIN DISC, INCORPORATED

222 E. Erie Street, Suite 400
Milwaukee, Wisconsin 53202
United States of America
Telephone: +1 (262) 638-4000
Email: sales@twindisc.com

TWIN DISC INTERNATIONAL SRL

Chaussé de Namur, 54
B-1400 Nivelles
Belgium

TWIN DISC SRL

Via S. Cristoforo 131
40017 S. Matteo Della Decima (BO)
Italy
Telephone: +39 051 6819711
Email: info.technodrive@twindisc.com
Email: info.twindiscsrl@twindisc.com

ROLLA SP PROPELLERS SAGL

Via Roncaglia 6
P.O. Box 109
Novazzano, 6883
Switzerland
Telephone: + 41(0)91 695 2000
Email: info@rolla-propellers.ch

TWIN DISC (PACIFIC) PTY. LTD.

70B Tradecoast Drive
Eagle Farm, QLD 4009
Australia
Telephone: +61 (7) 3265-1200
Email: info@twindisc.com.au

TWIN DISC (FAR EAST) PTE. LTD.

6, Tuas Avenue 1
Singapore 639491
Telephone: (65) 6267 0800
Email: tan.desmond@twindisc.com

VETH PROPULSION

Nanengat 17
3356 AA Papendrecht
The Netherlands
Telephone: +3178 615 22 66
Email: info@veth.net

KATSA OY

Ilmailunkatu 23
FI-33900 Tampere
Finland
Telephone: +358 3 315 151
Email: katsagears@katsa.fi

KOBELT

8238 129th Street
Surrey, BC V3W 0A6
Canada
Telephone: +1 (604) 590-7313
Email: sales@kobelt.com

TWIN DISC POWER TRANSMISSION PRIVATE, LTD.

EL Heights, 1st Floor
3 CMM Street
Nungambakkam, Chennai – 600034
India
Telephone: +91(44)2821 3099

TWIN DISC POWER TRANSMISSION (SHANGHAI) CO. LTD.

Shanghai Representative Office
Room 2308, No. 88 South Zun Yi Road
Chang Ning District, 200336
China
Telephone: +86 (21) 6427 3212
+86 (21) 6209 7626
Email: enquiry@twindisc.com.cn

TWIN DISC EUROPEAN DISTRIBUTION SRL

Chaussé de Namur, 54
B-1400 Nivelles
Belgium
Telephone: +32 (0) 67 887 211
Email: tdbelgium@twindisc.com



Click for the most
current locations of our
Global Service Network



TWIN DISC, INCORPORATED
4600 21st Street
Racine, Wisconsin 53405
United States of America
Telephone: +1(262)554-0640

TWIN DISC NORTH AMERICAN DISTRIBUTION CENTER
2000 S. Sylvania Avenue
Sturtevant, Wisconsin 53177
United States of America
Telephone: +1(262)554-0640

TWIN DISC, INCORPORATED
1007 Commerce Center Drive
Lufkin, Texas 75901
United States of America
Telephone: +1(936)707-3107

TWIN DISC SRL
Via S. Cristoforo 131
40017 S. Matteo Della Decima (BO)
Italy
Telephone: +39 051 6819711
Email: info.technodrive@twindisc.com
Email: info.twindiscsrl@twindisc.com

KATSA
Lakalaivankatu 6
FI-33840 Tampere
Finland
Telephone: +358 3 315 151
Email: katsagears@katsa.fi

KATSA
Marskinkatu 25
FI-39500 Ikaalinen
Finland
Telephone: +358 3 315 151
Email: katsagears@katsa.fi

TWIN DISC (PACIFIC) PTY LTD
QUEENSLAND BRANCH OFFICE – GOLD COAST
L4/1 Boatworks Drive
Coomera, QLD 4009
Australia
Telephone: +61(7)5613-3095
Email: info@twindisc.com.au

TWIN DISC POWER TRANSMISSION PVT LTD –
BRANCH OFFICE
S.F. No. 301/1B, Vilankurichi Road
Peelamedu, Coimbatore – 641004
India
Telephone: +91 63851 72625

TWIN DISC, INC. –
GUANGZHOU REPRESENTATIVE OFFICE
Room 908, Building C, 11 Yiyang Street
Xi Gang Road (M), Hai Zhu District
Guangzhou, 510315
China
Telephone: +86-20-3435 0927
Email: jason.yang@twindisc.com.cn

TWIN DISC JAPAN
(Partially-owned subsidiary)
Twin Disc Nico Co. Ltd.
405-3, Yoshinocho 1-chome, Kita-ku
Saitama-shi, Saitama-ken, 331-0811
Japan
Telephone: +81(48)652-8069
Email: info@tdnico.com

CONTINUE EXPLORING AT

TWINDISC.COM

Your voyage doesn't end here – it's just the beginning! This brochure gave you a glimpse, but our website is your passport to more in-depth information to help you confidently navigate the challenging sea of new options.



WHAT YOU WILL FIND

Comprehensive Product Information

Technical Specifications

Robust Sales & Service Locator

Resources, News and Events

And More

**YOUR CURIOSITY LED
YOU HERE; NOW, LET OUR
EXPERTISE GUIDE YOU.**

Visit our website to take control of your journey and find out how we can put horsepower to work for you.

MAKE TWIN DISC YOUR PROPULSION PARTNER

From system-design consultation to application development to in-service support, Twin Disc will partner with you to provide fully integrated propulsion solutions that will optimize your craft's performance, reliability and safety over the years. Bring Twin Disc aboard early in the development process, and you'll enjoy a lifetime of enhanced operating value and optimal cost of ownership.

For assistance with a specific application, please email applications@twindisc.com.

TWIN DISC
FAMILY OF
PRODUCTS

VETH PROPULSION KATSA KOBELT MASTER CLUTCH™

TECHNODRIVE ARNESON EXPRESS POSITIONING™

ROLLA QUICKSHIFT EXPRESS JOYSTICK SYSTEM™



USA • AUSTRALIA • BELGIUM • CANADA • CHINA
FINLAND • INDIA • ITALY • JAPAN • NETHERLANDS
SINGAPORE • SWITZERLAND • NEW ZEALAND